



GARANTIE
5
ans

www.sopal.com

SOPAL



MAÎTRISER
LA NATURE

L'eau est la source de toute forme de vie

Du ciel à l'océan, en passant par montagnes et vallées, l'eau circule sous ses états liquide, solide et gazeux depuis plus de 3 milliards d'années.

Assainie, rendue potable, puis distribuée, l'eau rejaillit dans les réseaux de vie humaine avec toute sa force et énergie originelles.

A travers sa chaîne de produits, **SOPAL** reconduit l'eau dans tous les domiciles en préservant sa force vitale et en lui attribuant la maîtrise, la sécurité, le confort, et la beauté nécessaires à votre espace de vie.

Water is the source of all life

From the sky to the ocean, through mountains and valleys, water has been circulating in its liquid, solid and gaseous states for more than 3 billion years.

Sanitized, made drinkable and then distributed, water flows back into the networks of human life with all its original strength and energy.

Through its chain of products, **SOPAL** returns water to all homes while preserving its vital force and giving it the control, safety, comfort and beauty necessary for your living space.

SOMMAIRE

SUMMARY



06

DES TECHNOLOGIES AU SERVICE DE L'ÉCOLOGIE ET DE VOTRE CONFORT

TECHNOLOGIES AT THE SERVICE OF THE ECOLOGY AND YOUR COMFORT



10

ESPACE BAIN ET DOUCHE

BATH AND SHOWER SPACE



66

ACCESSOIRES DE ROBINETTERIE SANITAIRE

SANITARY FAUCETS ACCESSORIES



84

CABINES DE DOUCHE / PAROIS DE BAIGNOIRE

SHOWER ENCLOSURES / BATHTUB SCREENS



110

ACCESSOIRES DE SALLE DE BAIN

BATHROOM ACCESSORIES



126

ESPACE CUISINE

KITCHEN SPACE



136

ROBINETTERIE POUR COLLECTIVITÉS

COMMUNITIES TAPS

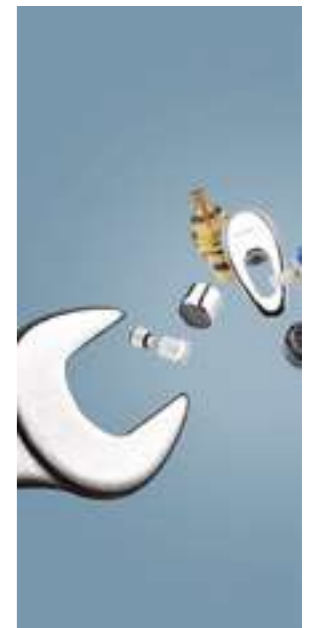

142

PIÈCES DE RECHANGE

SPARE PARTS

DES TECHNOLOGIES AU SERVICE DE L'ÉCOLOGIE ET DE VOTRE CONFORT

TECHNOLOGIES THAT SERVE THE ECOLOGY AND YOUR COMFORT

Au fil des années, SOPAL n'a cessé de focaliser ses efforts sur des solutions techniques et esthétiques pour un confort optimal et une expérience d'utilisation agréable.

Elle a su concilier dans cette démarche les impératifs écologiques et économiques.

Over the years, SOPAL has constantly focused its efforts on technical and aesthetic solutions for optimal comfort and pleasant user experience.

It has been able to reconcile ecological and economic imperatives in this approach.



Economie d'eau / Water saving



Jusqu'à **50% d'économie d'eau**

Up to 50% water savings



Economie d'énergie / Energy saving



Démarrage **sans consommation d'énergie**

Start-up without energy consumption

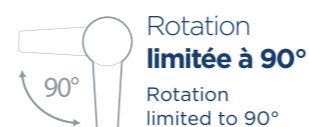

Robinet électronique / Electronic faucet

Hygiène **et économie d'eau**

Hygiene and water saving



1 litre
Robinet électronique
Electronic faucet



6 litres
Robinet traditionnel
Traditional faucet



Jusqu'à 80% d'économie d'eau:
Up to 80% water savings



Hygiène optimale
Optimal hygiene



Robinet temporisé / Self closing

Économie d'eau

Water saving

Temps d'écoulement / Flow time

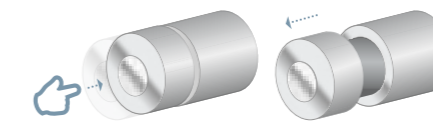

8-10 SEC
ROBINETS DE LAVABO + URINOIR
BASIN AND URINAL FAUCETS

15-20 SEC
ROBINETS DE DOUCHE
SHOWER FAUCETS



Le mitigeur **ne brûle pas pendant le passage d'eau chaude**

The mixer does not burn during the passage of hot water



Parois hermétiques du mitigeur
Mixer with hermetic walls

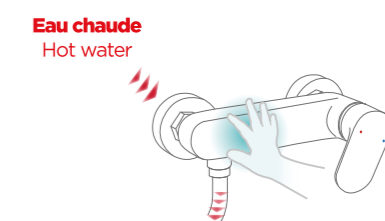

Levier «Joystick» / Joystick handel

L'ergonomie et le confort **au bout du doigt**

Ergonomics and comfort at your fingertips

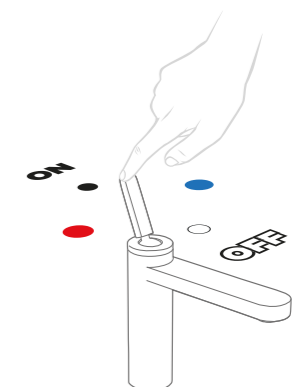

AVANTAGES PRODUITS PRODUCTS ADVANTAGES

FINITION / ASPECT



Finition brillante à effet miroir qui offre un nettoyage facile, une résistance aux chocs et une conservation d'une surface étincelante durant de longues années.

Glossy finish with a mirror effect that offers an easy cleaning, shock resistance and conservation of a sparkling surface for many years.



Alliant chrome et aluminium, la finition Inox offre une haute résistance à l'eau et une surface robuste avec un aspect esthétique moderne.

Combining chrome and aluminum, the stainless steel finish offers a high water resistance and a robust surface with a modern aesthetic appearance.

BUSES ET MOUSSEURS / NOZZLES AND FOAMERS



Mousseur intégré dans le bec avec un montage/démontage très facile à l'aide d'une pièce de monnaie.

Frother integrated in the spout with easy assembly/disassembly using a coin.



Un nettoyage facile avec un simple passage du doigt sur les picots des douchettes et rain showers, pour faire disparaître instantanément le calcaire et les salissures.

An easy cleaning with a simple finger pass on the pimples of the showerheads and rain showers, to make limestone and dirt disappear instantly.



Cette fonctionnalité permet d'avoir un jet d'eau optimal mitigé en eau et en air pour avoir des gouttes d'eau plus légères et plus douces.

This feature allows to have an optimal water jet mixed in water and air to have lighter and softer water drops.

EXPÉRIENCE UTILISATEUR / USER EXPERIENCE



Fonctionnalité propre aux produits à becs hauts et permet de gagner de l'espace entre le bec du mitigeur et le plan de lavabo/évier pour un confort d'utilisation maximal.

This feature is specific to high-mouthed products and saves space between the mixer spout and the sink/sink plan for maximum comfort.



Bec en silicone caractérisé par sa mémoire de forme. Flexible et obéit parfaitement à tous vos mouvements.

Silicone spout characterized by its shape memory. Flexible and perfectly obeys all your movements.



Le bec extractible facilite l'exécution des tâches et permet d'atteindre tout les coins et recoins pour une liberté de mouvement extrême.

The extractable spout facilitates the execution of your tasks and allows you to reach all corners for extreme freedom of movement.



Bec mobile tournant à 360° offrant ainsi un confort d'utilisation avec un rayon d'action maximal.

360° Rotating mobile nozzle providing operating comfort with a maximum range of action.



Bec mobile tournant à 270° offrant ainsi un confort d'utilisation avec un rayon d'action xlarge.

270° Rotating mobile nozzle for ease of use with x large range.



Bec mobile tournant à 180° offrant ainsi un confort d'utilisation avec un rayon d'action large.

180° Rotating mobile spout thus offering a comfort of use with a wide radius of action.



Les robinets de collectivité SOPAL permettent de réaliser une économie en consommation d'eau quotidienne tout en assurant un confort optimal.

SOPAL Community Faucets Save On Daily Water Consumption While Ensuring Optimal Comfort.

TYPES DE JETS / JET TYPES



Jet diffus doux et parfait pour les utilisations quotidiennes.

Soft diffuse jet, perfect for everyday use.



Jet concentré, parfait pour éliminer les taches de graisse et les incrustations.

Concentrated jet, perfect for removing grease stains and inlays.

GARANTIE SOPAL SOPAL WARRANTY



Certifiée ISO 9001, SOPAL met à votre disposition une Garantie 5 ans contre tout défaut de fabrication. Une équipe opérationnelle hautement qualifiée vous assure un service après-vente réactif.

Nous assurons la disponibilité des pièces de rechange chez nos revendeurs.

Certified ISO 9001, SOPAL provides you a guarantee of 5 years against each defect in manufacture. A highly qualified and operational team ensures a reactive after-sale service.

We ensure the availability of spare parts at our resellers.



97 700 000





**ESPACE
BAIN & DOUCHE**
BATH & SHOWER
SPACE



NOUVEAUTÉ NOVELTY



MITIGEURS DE BAIN-DOUCHE SUR PIED
FLOOR BATH-SHOWER STANDING MIXERS



BIZERTE
MITIGEUR DE BAIN-DOUCHE SUR PIED
FLOOR BATH-SHOWER STANDING MIXER
CODE : 06DCA04



EL JEM
MITIGEUR DE BAIN-DOUCHE SUR PIED
FLOOR BATH-SHOWER STANDING MIXER
CODE : 06DBA04





SÉRIE SFAX SFAX SET

Sécurité eau chaude / Hot water security

Le mitigeur ne brûle pas pendant le passage d'eau chaude
The mixer does not burn during the passage of hot water

SAFE TOUCH

Parois hermétiques du mitigeur
Mixer with hermetic walls

Eau chaude
Hot water



MITIGEUR DE BIDET
BIDET MIXER
CODE : 06C3A04



MITIGEUR DE TOILETTE
LAVATORY MIXER
CODE : 06C4A04

Avec flexible et support with Holder and flexible hose



MITIGEUR DE VASQUE LONG
LONG NECK WASHBASIN MIXER
CODE : 06C8A04



MITIGEUR DE LAVABO LONG
HIGH WASHBASIN MIXER
CODE : 06CMA04



MITIGEUR DE LAVABO
WASHBASIN MIXER
CODE : 06C2A04



MITIGEUR DE BAIN-DOUCHE
BATH-SHOWER MIXER
CODE : 06C0A04

Avec flexible, douchette et support de douchette mobile
With hose, shower head and movable hand shower holder



ROBINET DE TOILETTE
LAVATORY FAUCET
CODE : 06CAA04

Avec flexible et support with Holder and flexible hose





MITIGEUR DE LAVABO ENCASTRÉ

EMBEDDED WASHBASIN MIXER

CODE : 06CKA04

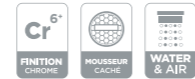

MITIGEUR DE BAIN-DOUCHE ENCASTRÉ

EMBEDDED BATH-SHOWER MIXER

CODE : 06CFA04



MITIGEUR DE TOILETTE ENCASTRÉ

EMBEDDED LAVATORY MIXER

CODE : 06CJA04



SÉRIE SFAX
SFAX SET

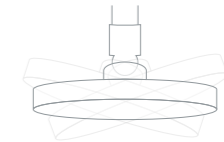

DOUCHETTE ORIENTABLE
ADJUSTABLE HEAD SHOWER



KIT MITIGEUR DE BAIN-DOUCHE ENCASTRÉ 3 SORTIES

EMBEDDED BATH-SHOWER MIXER KIT WITH 3 OUTPUTS

CODE : 06CHA04





Faites de votre douche un moment de pur bonheur et une expérience sensorielle apaisante, confortable et décontractée. Quelque soit le design de votre espace ou le type de votre installation, SOPAL fait en sorte que vous profitiez pleinement des plaisirs de la douche.

Make of your shower a moment of pure happiness, a comfortable and relaxing sensorial experience. Whatever your space design or your installation type is, SOPAL allows you to fully enjoy shower pleasure.



MITIGEUR DE DOUCHE
SHOWER MIXER
CODE : 06CIA04

Avec flexible 1,5 m, douchette et support de douchette
with showerhead, flexible hose and hand shower holder

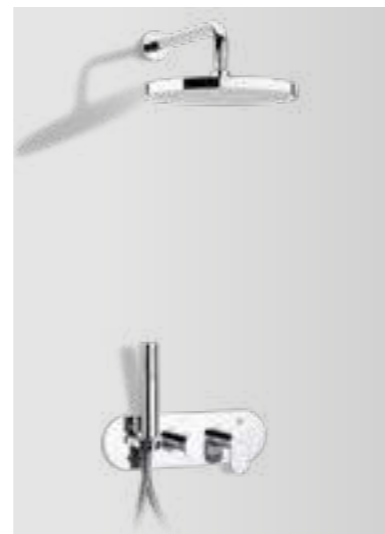

KIT MITIGEUR DE DOUCHE ENCASTRÉ AVEC INVERSEUR
EMBEDDED SHOWER MIXER KIT WITH DIVERTER
CODE : 06CEA04



SÉRIE SFAX SFAX SET

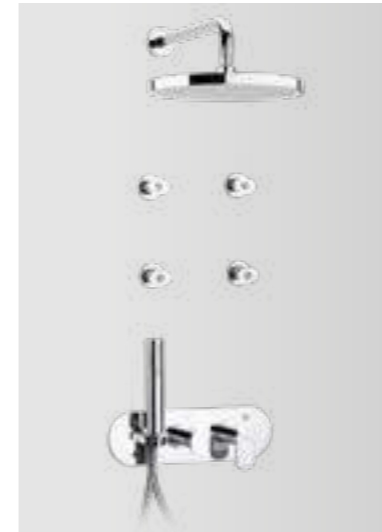
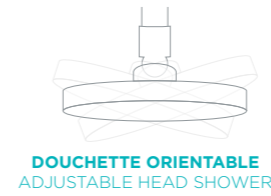

KIT MITIGEUR DE DOUCHE ENCASTRÉ AVEC INVERSEUR HYDROMASSAGE
EMBEDDED SHOWER MIXER KIT WITH HYDROMASSAGE DIVERTER
CODE : 06CUA04



NOUVEAUTÉ! NOVELTY!

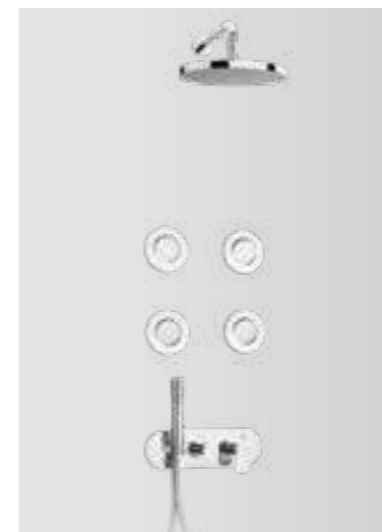

KIT MITIGEUR DE DOUCHE ENCASTRÉ HYDROMASSAGE AVEC 4 BUSES CYLINDRIQUES
EMBEDDED SHOWER MIXER KIT WITH HYDROMASSAGE 4 NOZZLES
CODE : 06DUA04



NOUVEAUTÉ! NOVELTY!



KIT MITIGEUR DE DOUCHE ENCASTRÉ HYDROMASSAGE AVEC 2 BUSES CYLINDRIQUES
EMBEDDED SHOWER MIXER KIT WITH HYDROMASSAGE 2 NOZZLES
CODE : 06DTA04



KIT MITIGEUR DE DOUCHE ENCASTRÉ
EMBEDDED SHOWER MIXER KIT
CODE : 06CGA04





SÉRIE NABEUL

NABEUL SET

Levier «Joystick» / Joystick handel

L'ergonomie et le confort au bout du doigt
Ergonomics and comfort at your fingertips

ONE TOUCH



MITIGEUR DE VASQUE LONG
LONG NECK WASHBASIN MIXER
CODE : 06BYA04



MITIGEUR DE LAVABO LONG
HIGH WASHBASIN MIXER
CODE : 06D2A04

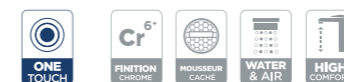

MITIGEUR DE LAVABO
WASHBASIN MIXER
CODE : 06BXA04





SÉRIE NABEUL NABEUL SET



MITIGEUR DE DOUCHE
SHOWER MIXER
CODE : 06BRA04



Avec flexible 1,5 m et douchette
with showerhead and flexible hose



MITIGEUR DE TOILETTE
LAVATORY MIXER
CODE : 06BVA04



Avec flexible
with flexible hose



Avec flexible, douchette et support de douchette mobile
With hose, shower head and movable hand shower holder

MITIGEUR DE BAIN-DOUCHE
BATH-SHOWER MIXER
CODE : 06BSA04



MITIGEUR DE BIDET
BIDET MIXER
CODE : 06C5A04



ROBINET DE TOILETTE
LAVATORY FAUCET
CODE : 06BZA04



Avec flexible et support
with Holder and flexible hose



SÉRIE ZARZIS ZARZIS SET



MITIGEUR DE BIDET

BIDET MIXER
CODE : 0638A04



MITIGEUR DE BAIN-DOUCHE

BATH-SHOWER MIXER
CODE : 0636A04



Avec flexible, douchette et support de douchette mobile
With hose, shower head and movable hand shower holder



MITIGEUR DE VASQUE LONG

LONG NECK WASHBASIN MIXER
CODE : 0647A04



MITIGEUR DE LAVABO LONG

HIGH WASHBASIN MIXER
CODE : 06CRA04



MITIGEUR DE LAVABO

WASHBASIN MIXER
CODE : 0645A04



MITIGEUR DE TOILETTE

LAVATORY MIXER
CODE : 0651A04



Avec flexible et support with Holder and flexible hose



ROBINET DE TOILETTE

LAVATORY FAUCET
CODE : 06D7A04



Avec flexible et support with Holder and flexible hose



SÉRIE ZARZIS

ZARZIS SET



MITIGEUR DE LAVABO ENCASTRÉ
EMBEDDED WASHBASIN MIXER
CODE : 06BNA04



MITIGEUR DE TOILETTE ENCASTRÉ
EMBEDDED LAVATORY MIXER
CODE : 06BPA04



MITIGEUR DE BAIN-DOUCHE ENCASTRÉ
EMBEDDED BATH-SHOWER MIXER
CODE : 06BJA04



KIT MITIGEUR DE BAIN-DOUCHE ENCASTRÉ 3 SORTIES

EMBEDDED BATH-SHOWER MIXER KIT 3 OUTPUTS
CODE : 06BKA04



SÉRIE ZARZIS

ZARZIS SET

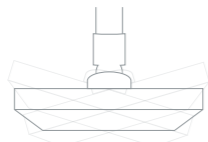

DOUCHETTE ORIENTABLE
ADJUSTABLE HEAD SHOWER



KIT MITIGEUR DE DOUCHE ENCASTRÉ AVEC INVERSEUR

EMBEDDED SHOWER MIXER KIT
WITH DIVERTER
CODE : 06BLA04



KIT MITIGEUR DE DOUCHE ENCASTRÉ

EMBEDDED SHOWER MIXER
CODE : 06BMA04



NOUVEAUTÉ! NOVELTY!



BARRE DE DOUCHE EN LAITON

BRASS SHOWER BAR
CODE : 10B8A04



BARRE DE DOUCHE

SHOWER BAR
CODE : 1034A04

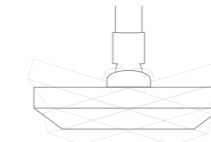

DOUCHETTE ORIENTABLE
ADJUSTABLE HEAD SHOWER

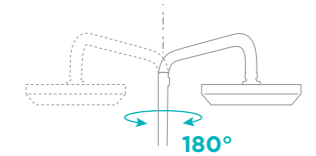

AVEC ROTATION
WITH ROTATION



COLONNE DE DOUCHE AVEC INVERSEUR

SHOWER COLUMN WITH DIVERTER
CODE : 1088A04

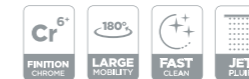

COLONNE DE DOUCHE

SHOWER COLUMN
CODE : 10A7A04



MITIGEUR DE DOUCHE

SHOWER MIXER
CODE : 06D8A04

Avec flexible 1,5 m, douchette et support de douchette
with showerhead, flexible hose
and hand shower holder



MITIGEUR DE DOUCHE CENTRÉ

CENTRED SHOWER MIXER
CODE : 06D5A04

Avec flexible 1,5 m, douchette et support de douchette
with showerhead, flexible hose
and hand shower holder





SÉRIE BIZERTE BIZERTE SET



MITIGEUR DE BAIN-DOUCHE
BATH-SHOWER MIXER
CODE : 0637A04



Avec flexible, douchette et support de douchette mobile
With hose, shower head and movable hand shower holder

NOUVEAUTÉ!
NOVELTY! ✨



ROBINET DE LAVABO
WASHBASIN FAUCET
CODE : 06DWA04



MITIGEUR DE BIDET
BIDET MIXER
CODE : 0639A04



MITIGEUR DE TOILETTE
LAVATORY MIXER
CODE : 0650A04



Avec flexible et support
with Holder and flexible hose



MITIGEUR DE VASQUE LONG
LONG NECK WASHBASIN MIXER
CODE : 0646A04



MITIGEUR DE LAVABO LONG
HIGH WASHBASIN MIXER
CODE : 06CQA04



MITIGEUR DE LAVABO
WASHBASIN MIXER
CODE : 0644A04



ROBINET DE TOILETTE
LAVATORY FAUCET
CODE : 06D6A04



Avec flexible et support
with Holder and flexible hose

NOUVEAUTÉ!
NOVELTY! ✨



ROBINET DE TOILETTE PM
SMALL LAVATORY FAUCET
CODE : 06DZA04



Avec flexible et support
with Holder and flexible hose

SÉRIE BIZERTE
BIZERTE SET



MITIGEUR DE TOILETTE ENCASTRÉ

EMBEDDED LAVATORY MIXER
CODE : 06B5A04



MITIGEUR DE LAVABO ENCASTRÉ

EMBEDDED WASHBASIN MIXER
CODE : 06B4A04



MITIGEUR DE BAIN-DOUCHE ENCASTRÉ

EMBEDDED BATH-SHOWER MIXER
CODE : 06B2A04



MITIGEUR DE DOUCHE

SHOWER MIXER
CODE : 06D4A04



Avec flexible 1,5 m, douchette et support de douchette
with showerhead, flexible hose and hand shower holder



KIT MITIGEUR DE DOUCHE ENCASTRÉ
EMBEDDED SHOWER MIXER KIT
CODE : 06D0A04



SÉRIE BIZERTE
BIZERTE SET

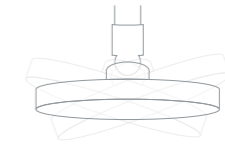

DOUCHETTE ORIENTABLE
ADJUSTABLE HEAD SHOWER



KIT MITIGEUR DE DOUCHE ENCASTRÉ
AVEC INVERSEUR

EMBEDDED SHOWER MIXER KIT
WITH DIVERTER
CODE : 06CZA04



SÉRIE BIZERTE

BIZERTE SET

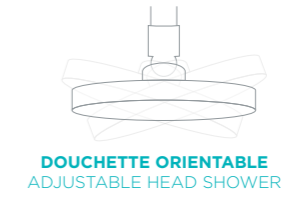
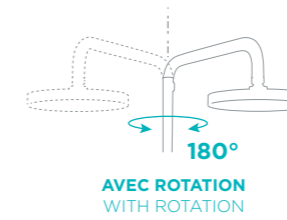

NOUVEAUTÉ!
NOVELTY!



BARRE DE DOUCHE EN LAITON
BRASS SHOWER BAR
CODE : 10B7A04



BARRE DE DOUCHE
SHOWER BAR
CODE : 1033A04



COLONNE DE DOUCHE
SHOWER COLUMN
CODE : 10A6A04



COLONNE DE DOUCHE AVEC INVERSEUR
SHOWER COLUMN WITH DIVERTER
CODE : 1087A04





SÉRIE SOUSSE

SOUSSE SET



MITIGEUR DE BAIN-DOUCHE

BATH-SHOWER MIXER
CODE : 0610A04



Avec flexible, douchette et support de douchette mobile
With hose, shower head and movable hand shower holder



MITIGEUR DE BIDET

BIDET MIXER
CODE : 0614A04



MITIGEUR DE TOILETTE

LAVATORY MIXER
CODE : 0615A04



Avec flexible et support with Holder and flexible hose



ROBINET DE TOILETTE

LAVATORY FAUCET
CODE : 06D9A04



Avec flexible et support with Holder and flexible hose



MITIGEUR DE VASQUE LONG

LONG NECK WASHBASIN MIXER
CODE : 0627A04



MITIGEUR DE LAVABO

WASHBASIN MIXER
CODE : 0611A04





SÉRIE SOUSSE SOUSSE SET



**2EN1 : BARRE
DE DOUCHE +
BARRE D'APPUI**

2 IN 1 : SHOWER
BAR + SUPPORT
BAR

BARRE DE DOUCHE ET D'APPUI

SHOWER & SUPPORT BAR
CODE : 1060A04



MITIGEUR DE DOUCHE

SHOWER MIXER
CODE : 06DAA04



Avec flexible 1,5 m,
douchette et support de
douchette
with showerhead,
flexible hose and hand
shower holder

**NOUVEAUTÉ!
NOVELTY!**



BARRE DE DOUCHE EN LAITON

BRASS SHOWER BAR
CODE : 10BAA04





SÉRIE SOUSSE SOUSSE SET

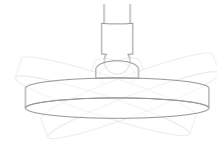

DOUCHETTE ORIENTABLE
ADJUSTABLE HEAD SHOWER



KIT MITIGEUR DE DOUCHE ENCASTRÉ

EMBEDDED SHOWER MIXER KIT
CODE : 06CVA04

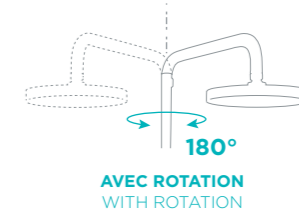

AVEC ROTATION
WITH ROTATION

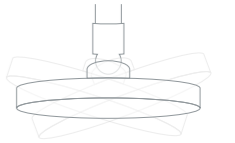

DOUCHETTE ORIENTABLE
ADJUSTABLE HEAD SHOWER

5 JETS



COLONNE DE DOUCHE AVEC INVERSEUR

SHOWER COLUMN WITH DIVERTER
CODE : 1089A04





SÉRIE DOUZ DOUZ SET



MITIGEUR DE VASQUE LONG
LONG NECK WASHBASIN MIXER
CODE : 06BCA04



MITIGEUR DE LAVABO LONG
HIGH WASHBASIN MIXER
CODE : 06D3A04



MITIGEUR DE LAVABO
WASHBASIN MIXER
CODE : 06ANA04



MITIGEUR DE BIDET
BIDET MIXER
CODE : 06ATA04



Economie d'énergie / Energy saving

Démarrage sans consommation d'énergie
Start-up without energy consumption

ENERGY SAVING

Cartouche avec position centrale sur l'eau froide
Cartidge with central position on cold water

Rotation limitée à 90°
Rotation limited to 90°

Eau froide / Cold water



SÉRIE DOUZ DOUZ SET



MITIGEUR DE BAIN-DOUCHE
BATH-SHOWER MIXER
CODE : 06AQA04



MITIGEUR DE TOILETTE
LAVATORY MIXER
CODE : 06ASA04



ROBINET DE TOILETTE
LAVATORY FAUCET
CODE : 06AUA04



NOUVEAUTÉ! ✨
NOVELTY!

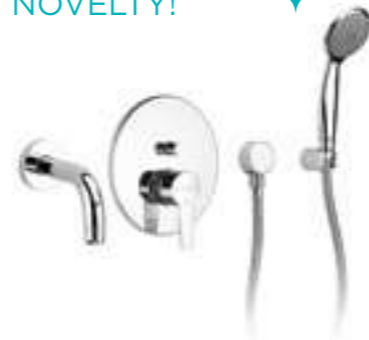

**MITIGEUR DE BAIN-DOUCHE ENCASTRÉ
AVEC INVERSEUR**
EMBEDDED BATH-SHOWER MIXER
CODE : 06DGA04



NOUVEAUTÉ! ✨
NOVELTY!



MITIGEUR DE TOILETTE ENCASTRÉ
EMBEDDED LAVATORY MIXER
CODE : 06DHA04



NOUVEAUTÉ! ✨
NOVELTY!



MITIGEUR DE LAVABO ENCASTRÉ
EMBEDDED WASHBASIN MIXER
CODE : 06DJA04





BARRE DE DOUCHE

SHOWER BAR
CODE : 10A9A04



SÉRIE DOUZ
DOUZ SET



KIT MITIGEUR DE DOUCHE ENCASTRÉ AVEC INVERSEUR

EMBEDDED SHOWER MIXER KIT WITH DIVERTER
CODE : 06CYA04

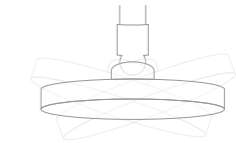
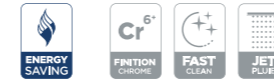

DOUCHETTE ORIENTABLE
ADJUSTABLE HEAD SHOWER



KIT MITIGEUR DE DOUCHE ENCASTRÉ

EMBEDDED SHOWER MIXER KIT
CODE : 06CXA04



MITIGEUR DE DOUCHE

SHOWER MIXER
CODE : 06ARA04



Avec flexible 1,5 m, douchette et support de douchette
with showerhead, flexible hose and hand shower holder



NOUVEAUTÉ!
NOVELTY!

SÉRIE ZEMBRA ZEMBRA SET



Economie d'énergie / Energy saving

Démarrage sans consommation d'énergie

Start-up without energy consumption



Cartouche avec **position centrale sur l'eau froide**
Cartidge with central position on cold water

Eau froide / Cold water



Rotation **limitée à 90°**
Rotation limited to 90°



MITIGEUR DE LAVABO

WASHBASIN MIXER
CODE : 06DLA04



MITIGEUR DE DOUCHE

SHOWER MIXER
CODE : 06DVA04



MITIGEUR DE TOILETTE

LAVATORY MIXER
CODE : 06ERA04



MITIGEUR DE BAIN-DOUCHE

BATH-SHOWER MIXER
CODE : 06DNA04



ROBINET DE TOILETTE

LAVATORY FAUCET
CODE : 06E3A04



SÉRIE DJERBA

DJERBA SET



MITIGEUR DE BAIN-DOUCHE
BATH-SHOWER MIXER
CODE : 0601A04



MITIGEUR DE LAVABO
WASHBASIN MIXER
CODE : 0602A04



MITIGEUR DE DOUCHE
SHOWER MIXER
CODE : 0608A04

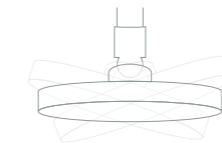

DOUCHETTE ORIENTABLE
ADJUSTABLE HEAD SHOWER



MITIGEUR DE VASQUE LONG
LONG NECK WASHBASIN MIXER
CODE : 0633A04



MITIGEUR DE TOILETTE
LAVATORY MIXER
CODE : 0606A04



ROBINET DE TOILETTE
LAVATORY FAUCET
CODE : 0609A04



MITIGEUR DE BIDET
BIDET MIXER
CODE : 0605A04



KIT MITIGEUR DE DOUCHE ENCASTRÉ
EMBEDDED SHOWER MIXER KIT
CODE : 06CWA04



NOUVEAUTÉ!
NOVELTY!



BARRE DE DOUCHE EN LAITON
BRASS SHOWER BAR
CODE : 10B9A04





SÉRIE KERKENNAH KERKENNAH SET



MITIGEUR DE LAVABO
WASHBASIN MIXER
CODE : 0620A04



MITIGEUR DE BAIN-DOUCHE
BATH-SHOWER MIXER
CODE : 0619A04



MITIGEUR DE BIDET
BIDET MIXER
CODE : 0622A04



NOUVEAUTÉ! ✨
NOVELTY!



MITIGEUR DE DOUCHE SORTIE HAUTE
SHOWER MIXER WITH UPPER OUTLET
CODE : 06DFA04



MITIGEUR DE DOUCHE
SHOWER MIXER
CODE : 0625A04



MITIGEUR DE TOILETTE
LAVATORY MIXER
CODE : 0623A04



ROBINET DE TOILETTE
LAVATORY FAUCET
CODE : 06CDA04



SÉRIE KERKENNAH

KERKENNAH SET



NOUVEAUTÉ!
NOVELTY!



DOUCHETTE ORIENTABLE
HEAD SHOWER WITH ROTATION

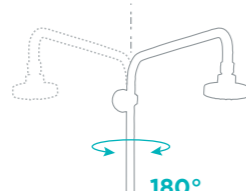

180°
AVEC ROTATION
WITH ROTATION

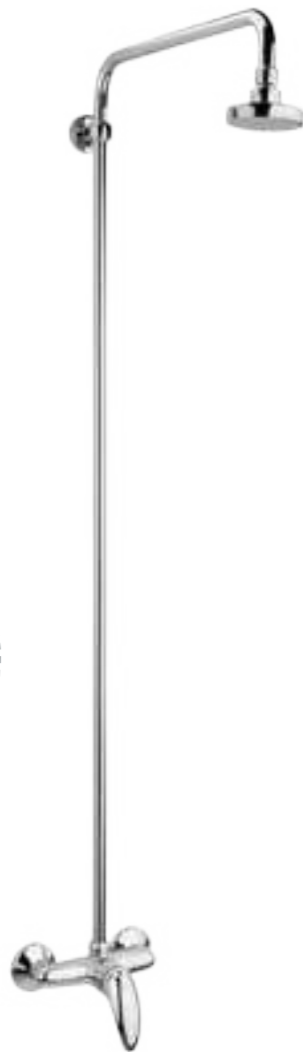

MONTAGE SIMPLE ET FONCTIONNEL
SIMPLE AND FUNCTIONAL MOUNTING

KIT MITIGEUR DE DOUCHE AVEC COLONNE

SHOWER MIXER KIT WITH COLUMN
CODE : 06DEA04



COLONNE DE DOUCHE INTÉGRÉE

INTEGRATED SHOWER COLUMN
CODE : 10B3A04



SÉRIE KORBA

KORBA SET



MITIGEUR DE LAVABO

WASHBASIN MIXER
CODE : 06AVA04



MITIGEUR DE BIDET

BIDET MIXER
CODE : 06AWA04

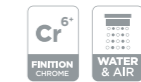

MITIGEUR DE BAIN-DOUCHE

BATH-SHOWER MIXER
CODE : 06AZA04



MITIGEUR DE DOUCHE

SHOWER MIXER
CODE : 06AYA04





SÉRIE MONASTIR MONASTIR SET



MÉLANGEUR DE LAVABO

WASHBASIN MIXER
CODE : 04B1A04



MÉLANGEUR DE LAVE-MAINS

HAND WASH MIXER
CODE : 04B6A04



MÉLANGEUR DE BIDET

BIDET MIXER
CODE : 04B4A04



MÉLANGEUR DE BAIN-DOUCHE

BATH-SHOWER MIXER
CODE : 04B0A04



Avec flexible, douchette et support de douchette mobile
With hose, shower head and movable hand shower holder



MÉLANGEUR DE DOUCHE

SHOWER MIXER
CODE : 04B3A04



MÉLANGEUR DE TOILETTE

LAVATORY MIXER
CODE : 04BRA04



Avec flexible et support
With holder and flexible hose



ROBINET DE TOILETTE

LAVATORY FAUCET
CODE : 04B8A04





SÉRIE TABARKA TABARKA SET



ROBINET VERTICAL
VERTICAL FAUCET
CODE : 04D9A04



MÉLANGEUR DE LAVABO
WASHBASIN MIXER
CODE : 04CWA04



MÉLANGEUR DE BAIN-DOUCHE
BATH-SHOWER MIXER
CODE : 04CRA04



Avec flexible, douchette et support de douchette mobile
With hose, shower head and movable hand shower holder



MÉLANGEUR DE DOUCHE
SHOWER MIXER
CODE : 04CVA04



MÉLANGEUR DE LAVE-MAINS
HAND WASH MIXER
CODE : 04CZA04



ROBINET DE LAVE-MAINS
HAND WASH FAUCET
CODE : 04CXA04



MÉLANGEUR DE BIDET
BIDET MIXER
CODE : 04CSA04



MÉLANGEUR DE TOILETTE
LAVATORY MIXER
CODE : 04CTA04



ROBINET DE TOILETTE
LAVATORY FAUCET
CODE : 0412A04





SÉRIE TOZEUR TOZEUR SET



ROBINET VERTICAL
VERTICAL FAUCET
CODE : 0457A04



MÉLANGEUR DE LAVE-MAINS
HAND WASH MIXER
CODE : 04AGA04



ROBINET DE LAVE-MAINS
HAND WASH FAUCET
CODE : 0458A04



MÉLANGEUR DE LAVABO
WASHBASIN MIXER
CODE : 0450A04



MÉLANGEUR DE BAIN-DOUCHE
BATH-SHOWER MIXER
CODE : 0449A04



Avec flexible, douchette et support de douchette mobile
With hose, shower head and movable hand shower holder



MÉLANGEUR DE DOUCHE
SHOWER MIXER
CODE : 0454A04



MÉLANGEUR DE BIDET
BIDET MIXER
CODE : 0452A04



MÉLANGEUR DE TOILETTE
LAVATORY MIXER
CODE : 0453A04



ROBINET DE TOILETTE
LAVATORY FAUCET
CODE : 0460A04



SÉRIE SALAKTA

SALAKTA SET



ROBINET VERTICAL
VERTICAL FAUCET
CODE : 04BPA04



MÉLANGEUR DE LAVABO
WASHBASIN MIXER
CODE : 04BAA04



ROBINET DE LAVE-MAINS
HAND WASH FAUCET
CODE : 04BLA04



MÉLANGEUR DE LAVE-MAINS
HAND WASH MIXER
CODE : 04BFA04



MÉLANGEUR DE BAIN-DOUCHE
BATH-SHOWER MIXER
CODE : 04B9A04

Avec flexible, douchette et support de douchette mobile
With hose, shower head and movable hand shower holder



MÉLANGEUR DE DOUCHE
SHOWER MIXER
CODE : 04BGA04



MÉLANGEUR DE TOILETTE
LAVATORY MIXER
CODE : 04BEA04



ROBINET DE TOILETTE
LAVATORY FAUCET
CODE : 04BNA04



MÉLANGEUR DE BIDET
BIDET MIXER
CODE : 04BDA04



ROBINET DE LAVABO LONG
LONG WASHBASIN FAUCET
CODE : 04DAA04



ROBINET DE LAVABO
WASHBASIN FAUCET
CODE : 04D0A04



ROBINET MURAL
WALL FAUCET
CODE : 04DBA04





**ACCESSOIRES DE
ROBINETTERIE
SANITAIRE**
SANITARY
FAUCETS
ACCESSORIES

COLONNES DE DOUCHES SHOWER COLUMNS

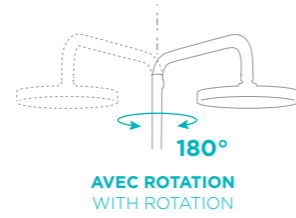
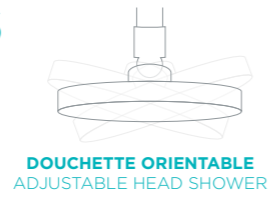

**COLONNE DE DOUCHE
AVEC INVERSEUR**
SHOWER COLUMN WITH DIVERTER
CODE : 1088A04



**COLONNE DE DOUCHE
AVEC INVERSEUR**
SHOWER COLUMN WITH DIVERTER
CODE : 1087A04



**COLONNE DE DOUCHE
AVEC INVERSEUR**
SHOWER COLUMN WITH DIVERTER
CODE : 1089A04



COLONNE DE DOUCHE
SHOWER COLUMN
CODE : 10A6A04



COLONNE DE DOUCHE
SHOWER COLUMN
CODE : 10A7A04



NOUVEAUTÉ!
NOVELTY!

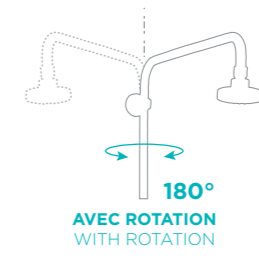

**KIT COLONNE DE DOUCHE
INTÉGRÉE AVEC ROBINET PM**
INTEGRATED SHOWER COLUMN KIT
WITH SMALL TAP
CODE : 06E0A04



MONTAGE SIMPLE ET
FONCTIONNEL
SIMPLE AND FUNCTIONAL
MOUNTING

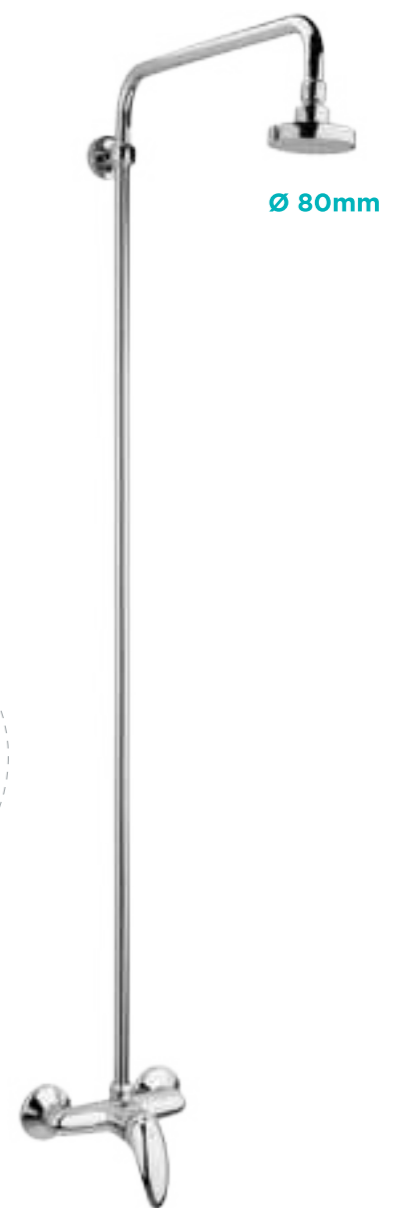

**KIT MITIGEUR DE DOUCHE
AVEC COLONNE**
SHOWER MIXER KIT WITH COLUMN
CODE : 06DEA04



BARRES DE DOUCHES SHOWER BARS



NOUVEAUTÉS!
NOVELTIES! ✨



BARRE DE DOUCHE
SHOWER BAR
CODE : 1033A04



BARRE DE DOUCHE
SHOWER BAR
CODE : 10A9A04



BARRE DE DOUCHE EN LAITON
BRASS SHOWER BAR
CODE : 10B8A04



BARRE DE DOUCHE EN LAITON
BRASS SHOWER BAR
CODE : 10B7A04



BARRE DE DOUCHE
SHOWER BAR
CODE : 1034A04

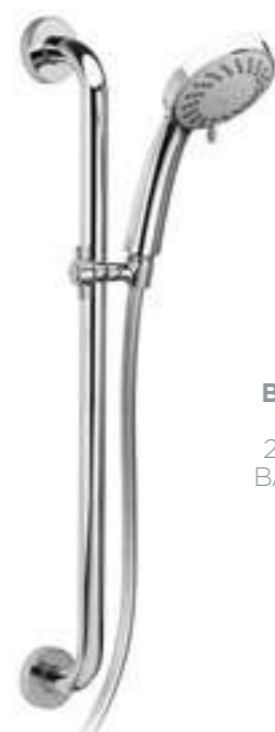

**2EN1 : BARRE
DE DOUCHE +
BARRE D'APPUI**

**2 IN 1 : SHOWER
BAR + SUPPORT
BAR**

BARRE DE DOUCHE ET D'APPUI
SHOWER & SUPPORT BAR
CODE : 1060A04



BARRE DE DOUCHE EN LAITON
BRASS SHOWER BAR
CODE : 10BAA04



BARRE DE DOUCHE EN LAITON
BRASS SHOWER BAR
CODE : 10B9A04

RAIN SHOWERS EXTRA PLAT

EXTRA FLAT RAIN SHOWERS

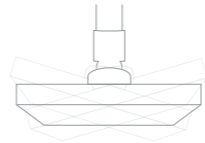

DOUCHETTE ORIENTABLE
ADJUSTABLE HEAD SHOWER

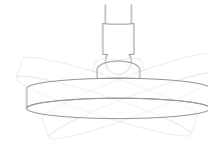

DOUCHETTE ORIENTABLE
ADJUSTABLE HEAD SHOWER

BRAS DE DOUCHE MURAL CARRÉ

SQUARE WALL MOUNTED SHOWER ARM
CODE : 1051A04

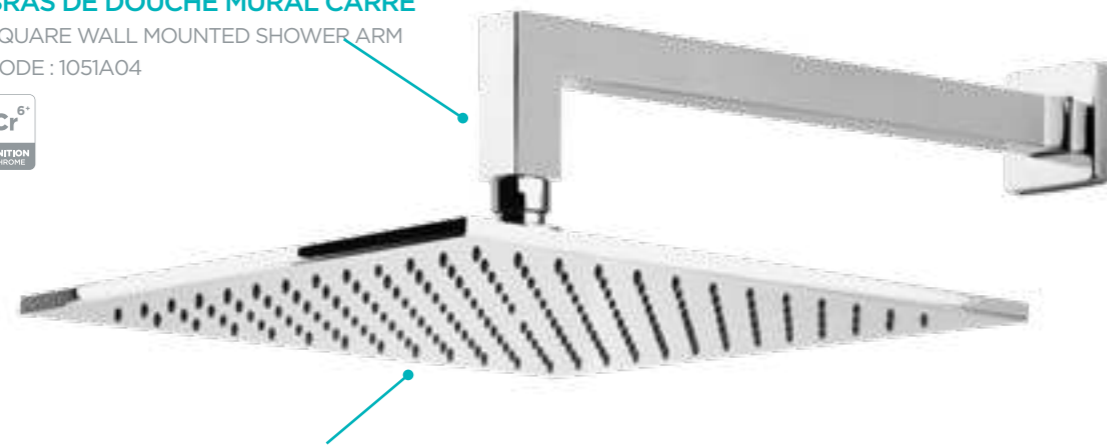

DOUCHE DE TÊTE CARRÉE INOX 300 X 300

SQUARE STAINLESS STEEL SHOWER HEAD 300 X 300
CODE : 10AQA04

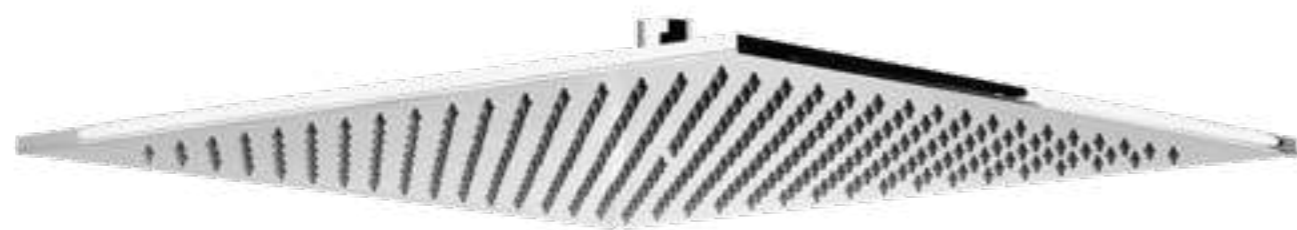

DOUCHE DE TÊTE CARRÉE INOX 400 X 400

SQUARE STAINLESS STEEL SHOWER HEAD 400 X 400
CODE : 10APA04



BRAS DE DOUCHE MURAL ROND

ROUND WALL MOUNTED SHOWER ARM
CODE : 1052A04



DOUCHE DE TÊTE RONDE INOX Ø 300

ROUND STAINLESS STEEL SHOWER HEAD Ø 300
CODE : 10ASA04



DOUCHE DE TÊTE RONDE INOX Ø 400

ROUND STAINLESS STEEL SHOWER HEAD Ø 400
CODE : 10ARA04



RAIN SHOWER

BRAS DE DOUCHE MURAL ROND
ROUND WALL MOUNTED SHOWER ARM
CODE : 1052A04

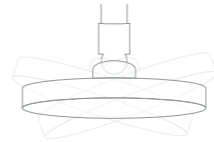

DOUCHETTE ORIENTABLE
ADJUSTABLE HEAD SHOWER

DOUCHE DE TÊTE RONDE Ø 200
ROUND SHOWER HEAD Ø 200
CODE : 1050A04



BRAS DE DOUCHE MURAL CARRÉ
SQUARE WALL MOUNTED SHOWER ARM
CODE : 1051A04

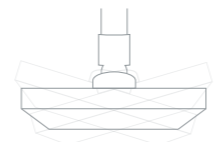

DOUCHETTE ORIENTABLE
ADJUSTABLE HEAD SHOWER

DOUCHE DE TÊTE CARRÉE 200X200
SQUARE SHOWER HEAD 200X200
CODE : 1049A04

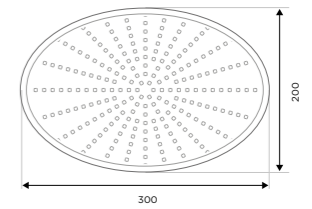

DOUCHE DE TÊTE OVALE
OVAL SHOWER HEAD
CODE : 10A8A04



BRAS DE DOUCHE PLAFONNIER ROND
ROUND CEILING MOUNTED SHOWER ARM



LONGUEUR/LENGTH	CODE
200	1081A04
300	10BEA04
400	10BFA04



BRAS DE DOUCHE PLAFONNIER CARRÉ
SQUARE CEILING MOUNTED SHOWER ARM



LONGUEUR/LENGTH	CODE
200	1080A04
300	10BGA04
400	10BHA04

DOUCHETTES SHOWER HEADS



SOUSSE
DOUCHETTE 5 JETS
5 JETS SHOWER HEAD
CODE : 1072A04

5 JETS

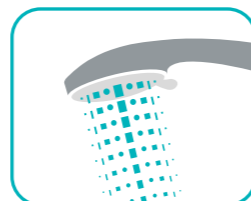

- 01
PLUIE
RAIN
- 02
BROUILLARD D'EAU
WATER MIST
- 03
PLUIE +
BROUILLARD D'EAU
RAIN + WATER MIST
- 04
MASSAGE D'EAU
WATER MASSAGING
- 05
PLUIE +
MASSAGE D'EAU
RAIN + WATER MASSAGING



ZARZIS
DOUCHETTE
SHOWER HEAD
CODE : 1036A04



DOUCHETTE ANTICALCAIRE
ANTI LIMESTONE SHOWER HEAD
CODE : 1005A04



DOUZ
DOUCHETTE
SHOWER HEAD
CODE : 1085A04



SFAX
DOUCHETTE
SHOWER HEAD
CODE : 1083A04



BIZERTE
DOUCHETTE
SHOWER HEAD
CODE : 1035A04



TABARKA
DOUCHETTE
SHOWER HEAD
CODE : 1004A04

SUPPORTS DE DOUCHETTE SHOWER HEAD HOLDERS



SUPPORT DE DOUCHETTE MOBILE
MOBILE SHOWER HOLDER
CODE : 1026A04



SUPPORT DE DOUCHETTE ORIENTABLE
ADJUSTABLE SHOWER HOLDER
CODE : 1071A04



KIT DE DOUCHETTE ANTICALCAIRE
ANTI LIMESTONE
SHOWER HEAD KIT
CODE : 1019A04

DOUCHETTES DE TOILETTE LAVATORY SHUT OFF

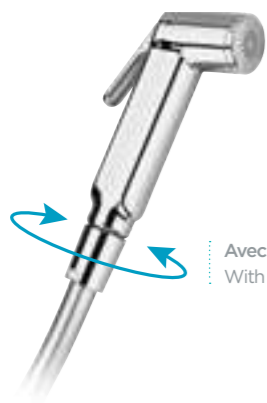

Avec flexible argent ANTI-TORSION
With ANTI-TWIST silver hose



**KIT POUR DOUCHETTE DE TOILETTE
CHROMÉE «SHUT OFF»**
CHROME-PLATED LAVATORY SHUT OFF
CODE : 10AYA04



**KIT POUR DOUCHETTE DE TOILETTE
BLANCHE «SHUT OFF»**
WHITE LAVATORY SHUT OFF
CODE : 10AZA10

ROSACES ESCUTCHEON



**ROSACE FEMELLE AVEC
OLIVE EN TÉFLON**
FEMALE ESCUTCHEON
WITH PTFE RING
CODE : 4008A04



**ROSACE MÂLE
AVEC OLIVE EN TÉFLON**
MALE ESCUTCHEON
WITH PTFE RING
CODE : 4009A04



**ROSACE FEMELLE
AVEC RACCORD POUR
MULTI-COUCHE**
FEMALE ESCUTCHEON
FOR MULTILAYER TUBES
CODE : 4017A04



**ROSACE MÂLE
AVEC RACCORD POUR
MULTICOUCHE**
MALE ESCUTCHEON
FOR MULTILAYER TUBES
CODE : 4018A04

FLEXIBLES SHOWER HOSES

NOUVEAUTÉ! ✨
NOVELTY!



**FLEXIBLE DE DOUCHE ARGENT
ANTI-TORSION**
ANTI-TWIST SILVER SHOWER HOSE
1,5M / CODE : 4474A00
2M / CODE : 4473A00



FLEXIBLE DE DOUCHE ARGENT
SILVER SHOWER HOSE
1,5M / CODE : 4446A00
2M / CODE : 4457A00

NOUVEAUTÉ! ✨
NOVELTY!



FLEXIBLE DE DOUCHE
SHOWER HOSE
1,5M / CODE : 4402B00
2M / CODE : 4403B00



FLEXIBLE DE DOUCHE BLANC 1,5M
SHOWER HOSE 1,5M
CODE : 4483A00

NOUVEAUTÉ! ✨
NOVELTY!



**FLEXIBLE DE TOILETTE
ARGENT ZARZIS 1 M**
ZARZIS SILVER LAVATORY
HOSE 1M
CODE : 4459A00



**FLEXIBLE DE TOILETTE
ARGENT BIZERTE 1M**
BIZERTE SILVER LAVATORY
HOSE 1M
CODE : 4460A00



FLEXIBLE DE TOILETTE 1M
LAVATORY HOSE 1M
CODE : 4401B00



**FLEXIBLE DE
TOILETTE BLANC 1M**
WHITE LAVATORY HOSE 1M
CODE : 4484A00

NOUVEAUTÉS!
NOVELTIES!

CANIVEAUX DE DOUCHE SHOWER CHANNELS

GRILLE EN INOX 316L
GRATE IN STAINLESS STEEL 316L

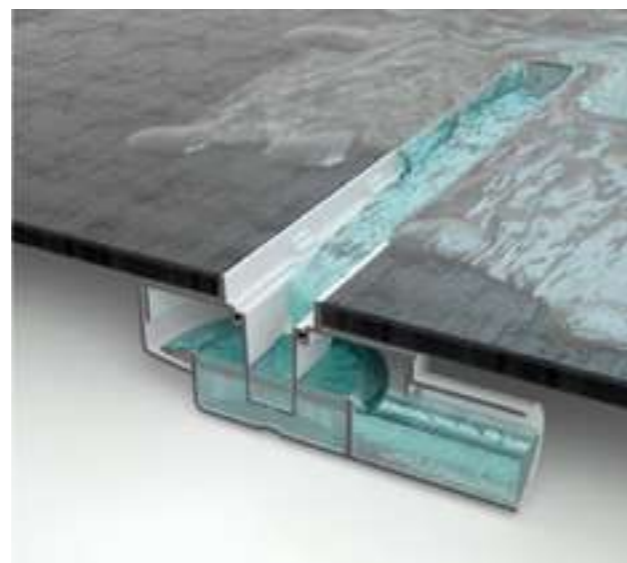
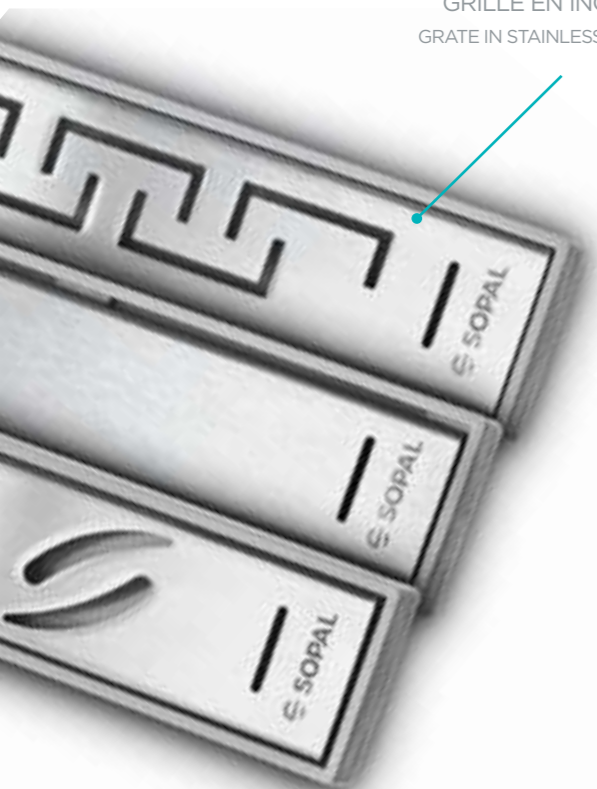

AVANTAGES ADVANTAGES



- Débit d'évacuation de l'eau Ultra Rapide
- Anti-odeurs et anti-insectes
- Hygiène et facilité d'entretien
- Ultra Fast water flow
- Anti-odors and anti-insects
- Hygiene and ease of maintenance

MODÈLE
MEDJERDA

MODÈLE 2 EN 1
2 IN 1 MODEL



FONCTION 1
GRILLE EN INOX PLATE
FLAT STAINLESS STEEL GRATE



FONCTION 2
À CARRELER
TO BE TILED

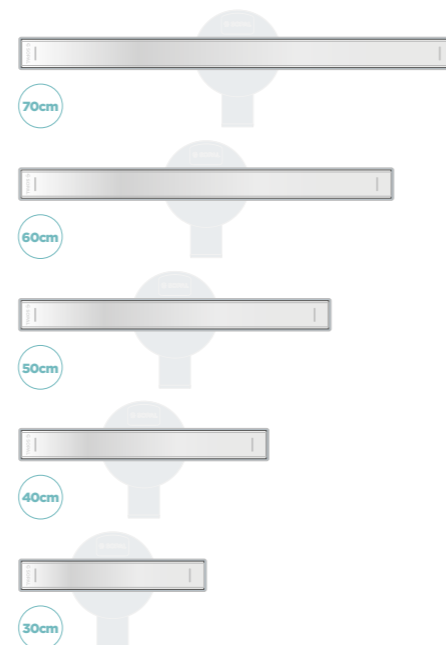
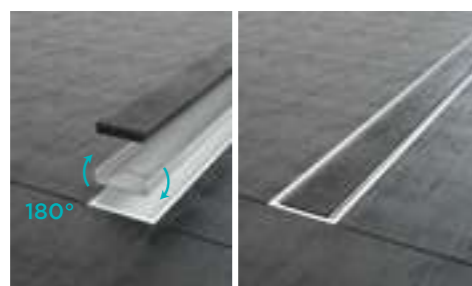

CODES
70 CM : 1955A00
60 CM : 1973A00
50 CM : 1956A00
40 CM : 1972A00
30 CM : 1957A00

MODÈLE SEJNENE



CODES
70 CM : 1955B00
60 CM : 1973B00
50 CM : 1956B00
40 CM : 1972B00
30 CM : 1957B00

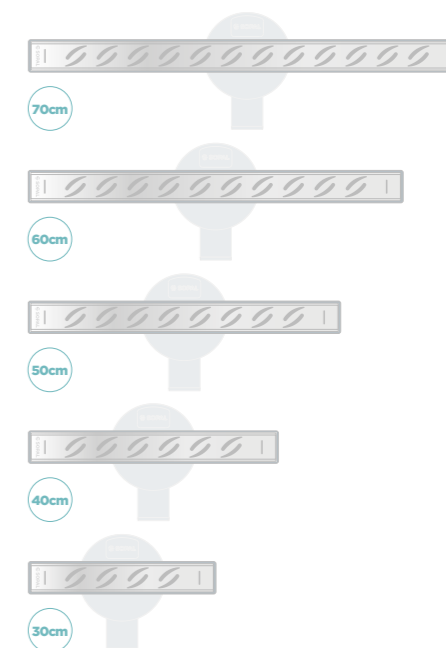

MODÈLE MELLEGUE



CODES
70 CM : 1955C00
60 CM : 1973C00
50 CM : 1956C00
40 CM : 1972C00
30 CM : 1957C00



SIPHON DE SOL EN INOX FLOOR SIPHONS



CODE : 1952A00



BONDES DE LAVABO
SINK DRAINERS



BONDE DE LAVABO CLIC CLAC RONDE
ROUND POP UP SINK DRAINER
CODE : 1958A00



BONDE DE LAVABO CLIC CLAC CARRÉE
SQUARE POP UP SINK DRAINER
CODE : 1959A00



BONDE DE LAVABO AUTOMATIQUE
AUTOMATIC WASHBASIN DRAINER
DIM. 32 / CODE : 1901A00
DIM. 40 / CODE : 1902A00

SIPHONS
SIPHONS



SIPHON ROND CHROMÉ
CHROMIUM-PLATED ROUND BASIN SIPHON
CODE : 1908A04



SIPHON CARRÉ CHROMÉ
CHROMIUM-PLATED SQUARE BASIN SIPHON
CODE : 1941A04



**CABINES DE
DOUCHE**
SHOWER
ENCLOSURES

SPÉCIFICATIONS GÉNÉRALES

GENERAL SPECIFICATIONS

Consciente des exigences d'un marché évolutif en perpétuelle mutation et soucieuse par son image de leader, SOPAL poursuit aujourd'hui sa quête de l'innovation en étendant son approche sur les besoins du consommateur. Une approche plus modernisée en matière d'esthétique et d'ergonomie.

A travers une collection variée et complète de cabines de douche, SOPAL double la performance et met tout son savoir-faire au service de ses clients en leur proposant des solutions innovantes et adaptées à leurs besoins.

Aware of the requirements of an evolving market in perpetual change and mindful of its image as a leader, SOPAL continues today its quest for innovation by extending its approach to consumer needs. A more modernized approach to ethics and ergonomics.

Through a varied and complete collection of shower enclosures, SOPAL doubles performance and puts all its know-how at the service of customers by offering them innovative solutions adapted to their needs.

TYPES D'INSTALLATION

TYPE OF INSTALLATION



WALK-IN
WALK-IN



EN NICHE
NICHE



EN ANGLE
ANGLE



PAROI FIXE
WALL FIX

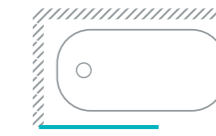

SUR BAIGNOIRE
ON BATHTUB

TYPES DE PORTES

DOORS TYPES



COULISSANT
SLIDING



PLIABLE
FOLDABLE



BATTANT
SWING

AVANTAGES :

- Profilé aluminium
- Vitre sécurit
- Accessoires en inox
- Flexibilité selon l'espace

BENEFITS:

- Aluminum profile
- Safety glass
- Stainless steel accessories
- Flexibility based on space



CABINE DE DOUCHE EN ANGLE
CORNER SHOWER ENCLOSURE



PAROI DE DOUCHE WALK-IN
WALK-IN SHOWER ENCLOSURE



CABINE DE DOUCHE EN NICHE
RECESS SHOWER ENCLOSURE



PAROI DE BAIGNOIRE
BATHTUB SCREEN



COLLECTION NIAGARA

NIAGARA COLLECTION

Cadres standard / Argent chromé
 Standard frames / Chrome silver

Vitres standards / Transparent, sablé
 Standard glass / Transparent, sandblasted

Caractéristiques Techniques

Technical characteristics



H 200 cm



6 mm



Extensible 1 cm
 Expandable 1 cm



Accès facile
 Easy access



Paroi fixe
 Installation: en angle
 Fixed wall
 Installation: corner

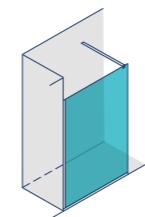

Paroi fixe avec 1 retour fixe
 Installation: en angle
 Fixed wall with 1 fixed return
 Installation: corner

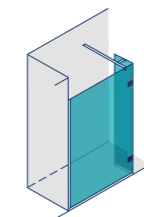

Paroi fixe avec 2 retours fixes
 Installation: avec bras de support
 Fixed wall with 2 fixed returns
 Installation: with arm support

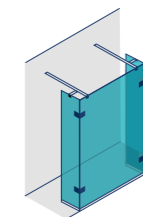

Paroi fixe avec 1 porte battante
 Installation: en angle
 Fixed wall with 1 hinged door
 Installation: corner

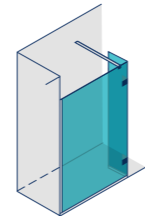

Paroi fixe
 Installation: avec bras de soutien
 Fixed wall
 Installation: with arm support

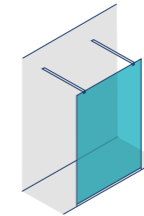



COLLECTION KASAI

KASAI COLLECTION

Cadres standard / Noir
Standard frames / Black

Vitres standards / Transparent, sablé
Standard glass / Transparent, sandblasted

Caractéristiques Techniques

Technical characteristics



H 200 cm 6 mm



Extensible : Niche 4 cm / Angle 3 et 4 cm
Expandable : Niche 4 cm / Angle 3 and 4 cm



Système coulissant visible sur la voie supérieure
Sliding system visible on the upper track



Accès facile
Easy access



Décrochage rapide de la porte pour faciliter le nettoyage
Quick release of the door for easy cleaning



Coulissant avec roulement à billes
Sliding with ball bearing



1 élément fixe + 1 porte coulissante
Installation: en niche
1 fixed element + 1 sliding door
Installation: niche

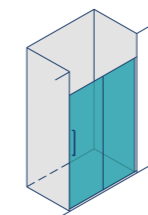

1 élément fixe + 1 porte coulissante / côté latéral: 1 fixe
Installation: en angle
1 fixed element + 1 sliding door / lateral side: 1 fixed
Installation: corner

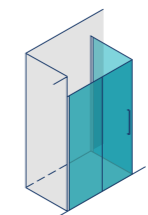



COLLECTION VOLTA

VOLTA COLLECTION

Cadres standard / Argent brillant
Standard frames / Shiny silver

Vitres standards / Transparent, sablé
Standard glass / Transparent, sandblasted

Caractéristiques Techniques

Technical characteristics



H 200 cm



6 mm



Extensible : Niche 4 cm / Angle 2 cm de chaque côté
Expandable : Niche 4 cm / Corner 2 cm from each part



Accès facile
Easy access



Ouverture à 180°
180° opening



Soulèvement des portes à l'ouverture
Lifting of doors when opening



1 porte repliable + 1 côté latéral fixe
Installation: en angle
1 folding door + 1 lateral side fixed
Installation: corner

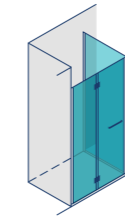

2 portes repliables
Installation: en angle
2 folding doors
Installation: corner

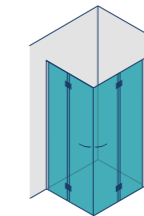

2 portes repliables
Installation: en niche
2 folding doors
Installation: niche

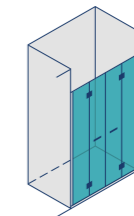

1 élément fixe + 1 porte repliable
Installation: en niche
1 fixed element + 1 folding door
Installation: niche

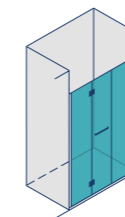

1 porte repliable
Installation: en niche
1 folding door
Installation: niche

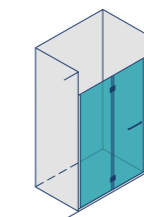



COLLECTION RIO

RIO COLLECTION

Cadres standard / Argent brillant
 Standard frames / shiny silver

Vitres standards / Peau d'orange, transparent, sablé
 Standard glass / Orange peel effect, transparent, sandblasted

Caractéristiques Techniques

Technical characteristics



H 200 cm 6 mm

 Extensible: Niche 4 cm / Angle 2 cm de chaque côté
 Expandable: Niche 4 cm / Corner 2 cm from each part

 Accès facile
 Easy access



1 porte battante + 1 élément fixe
 Installation: en niche
1 hinged door + 1 fixed element
 Installation: niche

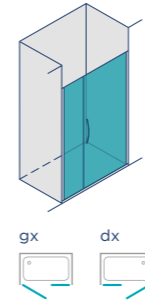

1 porte battante
 Installation: en niche
1 hinged door
 Installation: niche

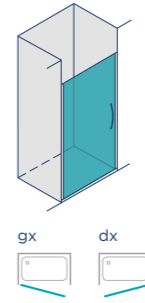

2 portes battantes
 Installation: en niche
2 hinged doors
 Installation: niche

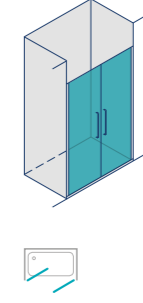

2 portes battantes
 Installation: en angle
2 hinged doors
 Installation: corner

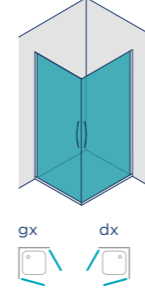

1 porte battante + 1 côté fixe
 Installation: en angle
1 hinged door + 1 fixed side
 Installation: corner

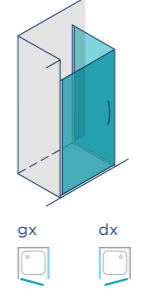



COLLECTION TANA TANA COLLECTION

Cadres standard / Argent brillant
Standard frames / Shiny silver

Vitres standards / Peau d'orange, transparent
Standard glass / Orange peel effect, transparent

Caractéristiques Techniques Technical characteristics



H 190 cm 6 mm



Extensible: Niche 7 cm / Angle 3 cm de chaque côté
Expandable: Niche 7 cm / Corner 3 cm from each part



Accès facile
Easy access



Réversible
Reversible



Coulissant avec roulement à billes
Sliding with ball bearing



Cet article n'est pas destiné à être installé séparément, le côté fixe est destiné pour installation avec une porte de douche pour créer un espace niche.

This item is not intended to be installed separately, the fixed side is intended for installation with a shower door to create a niche space.

2 éléments fixes
+ 2 portes coulissantes

Installation: en niche

2 fixed elements + 2 sliding doors
Installation: niche

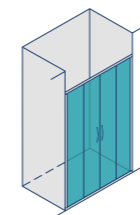

1 élément fixe
+ 1 porte coulissante

Installation: en niche

1 fixed element + 1 sliding door
Installation: niche

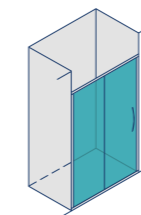

gx

dx



2 éléments fixes
+ 2 portes coulissantes

Installation: en angle

2 fixed elements + 2 sliding doors
Installation: corner

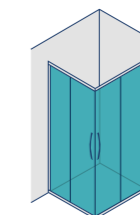

gx

dx



1 côté fixe

Installation: en coin

1 fixed side

Installation: corner

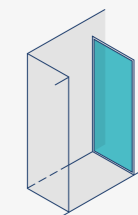

gx

dx





COLLECTION LENA

LENA COLLECTION

Cadres standard / Laqué blanc, argent brillant
Standard frames / White lacquered, shiny silver

Vitres standards / Peau d'orange, transparent, sablé
Standard glass / Orange peel effect, transparent, sandblasted

Caractéristiques Techniques

Technical characteristics



H 185 cm **4 mm**



Extensible: Niche 5 cm / Angle 11 cm de chaque côté
Expandable: Niche 5 cm / Corner 11 cm from each part



Réversible
Reversible



Couissant avec roulement à billes
Sliding with ball bearing



Cet article n'est pas destiné à être installé séparément, le côté fixe est destiné pour installation avec une porte de douche pour créer un espace niche.

This item is not intended to be installed separately, the fixed side is intended for installation with a shower door to create a niche space.

1 élément fixe + 1 porte coulissante
Installation: en niche
1 fixed element + 1 sliding door
Installation: niche

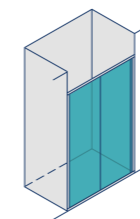

2 éléments fixes + 2 portes coulissantes
Installation: en angle
2 fixed elements + 2 sliding doors
Installation: corner

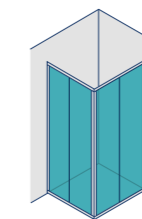

1 côté fixe
Installation: en coin
1 fixed side
Installation: corner

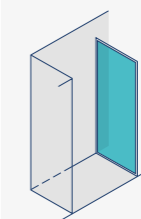



COLLECTION RIVIERA

RIVIERA COLLECTION

Cadres standard / Argent brillant
 Standard frames / Shiny silver

Vitres standards / Acrylique, peau d'orange, transparent, sablé
 Standard glass / Acrylic, orange peel effect, transparent, sandblasted

Caractéristiques Techniques

Technical characteristics



H 185 cm



3/4 mm



Extensible: 5 cm
 Expandable: 5 cm



Réversible
 Reversible



Cet article n'est pas destiné à être installé séparément, le côté fixe est destiné pour installation avec une porte de douche pour créer un espace niche.

This item is not intended to be installed separately, the fixed side is intended for installation with a shower door to create a niche space.

1 porte repliable
 Installation: en niche
1 Folding door
 Installation: niche

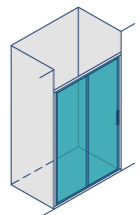

1 côté fixe
 Installation: en coin
1 fixed side
 Installation: corner

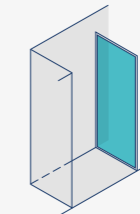



**PAROIS DE
BAIGNOIRE**
BATHTUB
SCREENS



COLLECTION NIAGARA

NIAGARA COLLECTION

Cadres standard / Argent chromé
Standard frames / chrome plated silver

Vitres standards / Transparent, sablé
Standard glass / Transparent, sandblasted

Caractéristiques Techniques

Technical characteristics



H 140 cm



6 mm



Accès facile
 Easy access



Extensible: 1 cm
 Expandable: 1 cm



1 Paroi fixe
 Installation: sur-baignoire
1 fixed wall
 Installation: on bath

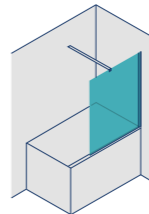



COLLECTION RIVIERA RIVIERA COLLECTION

Cadres standard / Argent brillant
Standard frames / Shiny silver

Vitres standards / Acrylique
Standard glass / Acrylic

Caractéristiques Techniques Technical characteristics



H 140 cm



3/4 mm



Accès facile
Easy access



Réversible
Reversible



Ouverture à 180°
180° opening



1 porte repliable en 3 parties
Installation: sur-baignoire
1 folding door in 3 parts
Installation: on bath

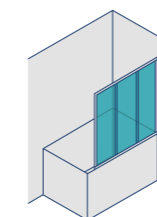

1 porte repliable en 3 parties - Côté latéral: 1 fixe
Installation: sur-baignoire
1 folding door in 3 parts - 1 fixed
Installation: on bath

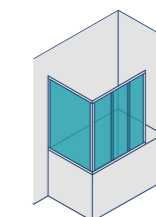



COLLECTION RIO

RIO COLLECTION

Cadres standard / Argent brillant
Standard frames / Shiny silver

Vitres standards / Acrylique, peau d'orange, transparent, sablé
Standard glass / Acrylic, orange peel effect, transparent, sandblasted

Caractéristiques Techniques

Technical characteristics



H 140 cm



6 mm



Extensible: 2 cm
Expandable: 2 cm



Ouverture à 180°
180° opening



Accès facile
Easy access



Soulèvement des portes à l'ouverture
Lifting of doors when opening



1 porte battante
 Installation: sur-baignoire
1 hinged door
 Installation: on bath

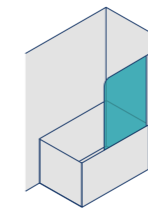

1 porte repliable
 Installation: sur-baignoire
1 folding door
 Installation: on bath

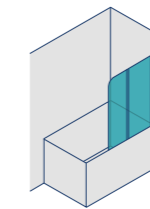

1 côté fixe
 Installation: en coin
1 fixed side
 Installation: corner

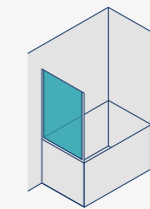

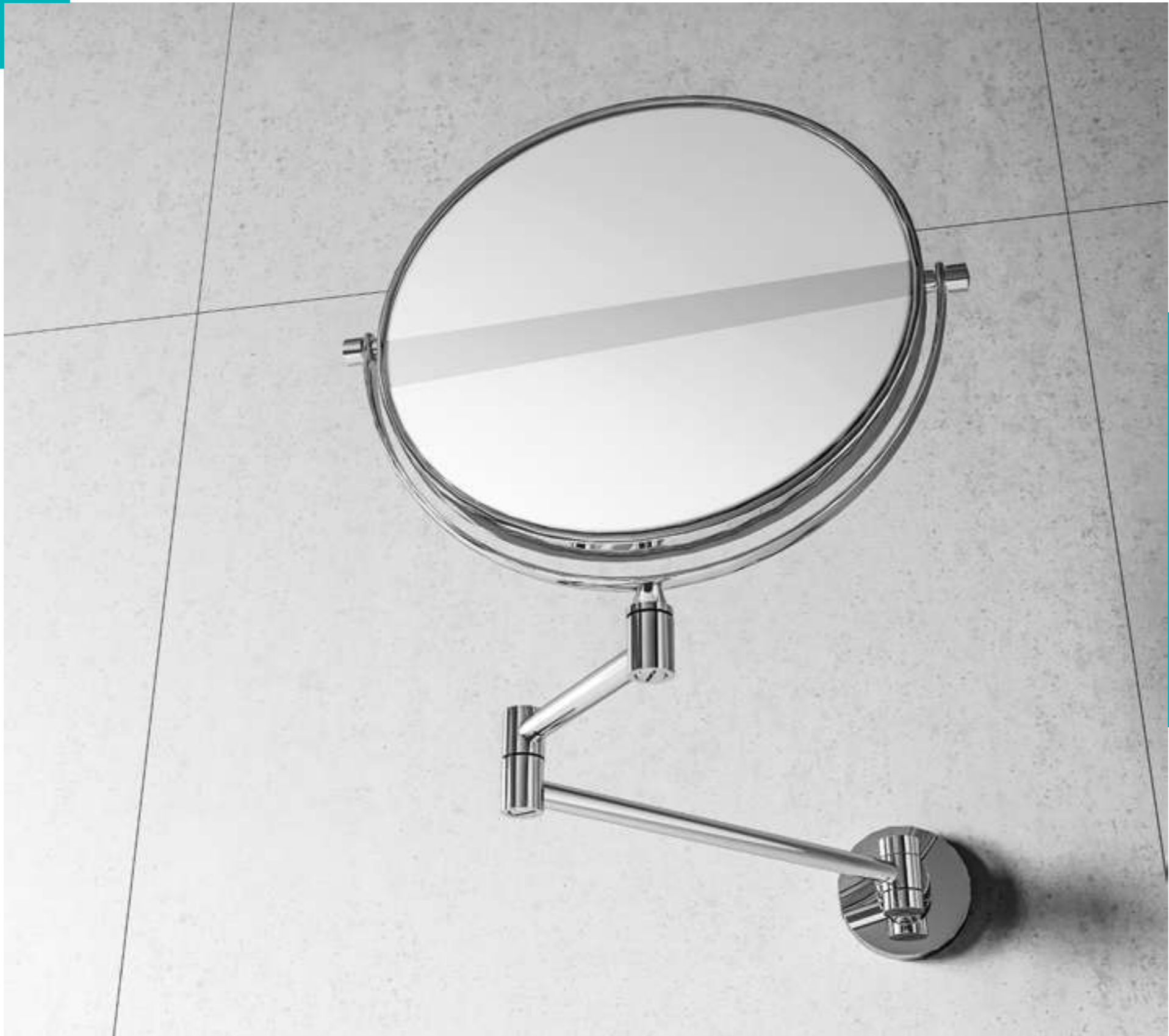

**ACCESSOIRES
DE SALLE DE
BAIN**

BATHROOM
ACCESSORIES

SÉRIE YASMINE

YASMINE SET



NOUVEAUTÉ! ✨
NOVELTY!



**DÉROULEUR DE PAPIER
AVEC COUVERCLE**
PAPER DISPENSER WITH COVER
CODE : SB83A04

NOUVEAUTÉ! ✨
NOVELTY!

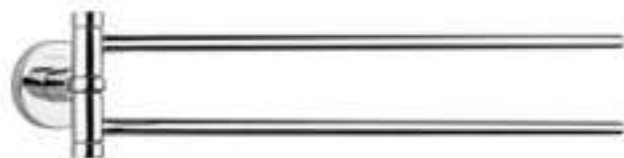

PORTE SERVIETTE DOUBLE MOBILE
DOUBLE MOBILE TOWEL HOLDER
CODE : SB73A04



PORTE ROULEAU DE PAPIER
NAPKIN HOLDER
CODE : SB26A04

NOUVEAUTÉ! ✨
NOVELTY!



PORTE PEIGNOIR
BATHROBE HOLDER
CODE : SB90A04



PORTE SERVIETTE ANNEAU
TOWEL RING HOLDER
CODE : SB62A04



PORTE BALAI MURAL
WALL MOUNTED TOILET BRUSH
CODE : SB32A04



PORTE VÊTEMENTS
ROBE HOOK
CODE : SB25A04



DÉROULEUR DE PAPIER
TOILET PAPER HOLDER
CODE : SB33A04



PORTE SAVON DE DOUCHE
SHOWER SOAP HOLDER
CODE : SB77A04



PORTE ROULEAUX DOUBLE
DOUBLE NAPKIN HOLDER
CODE : SB52A04



ETAGÈRE MURALE EN VERRE
WALL GLASS SHELF
CODE : SB75A04



ETAGÈRE DE COIN EN VERRE
CORNER SHELF
CODE : SB57A04

SÉRIE YASMINE
YASMINE SET



PORTE ESSUIE MAIN SIMPLE
SINGLE TOWEL HOLDER
CODE : SB66A04

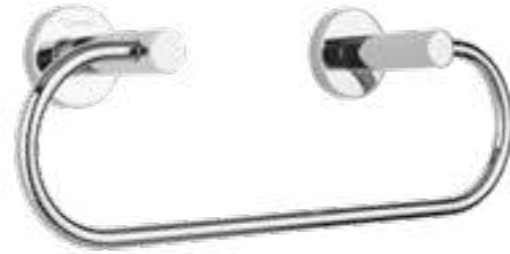

PORTE ESSUIE-MAINS
TOWEL HOLDER
CODE : SB29A04



PORTE SAVON
SOAP HOLDER
CODE : SB31A04



PORTE VERRE
CUP HOLDER
CODE : SB30A04



PORTE SERVIETTE SIMPLE
SINGLE TOWEL HOLDER
CODE : SB28A04



ETAGÈRE POUR SERVIETTES XL
XL RACK TOWEL
CODE : SB38A04



PORTE SERVIETTES DOUBLE
DOUBLE TOWEL HOLDER
CODE : SB27A04



ETAGÈRE POUR SERVIETTES
RACK TOWEL
CODE : SB36A04



TABLETTE DE LAVABO
SINK SHELF
CODE : SB35A04



TABLETTE DE LAVABO AVEC GARDE-CORPS
SINK SHELF WITH RAILING
CODE : SB68A04



TABLETTE DOUBLE
DOUBLE SHELF
CODE : SB37A04

SÉRIE WARD
WARD SET



PORTE VERRE
CUP HOLDER
CODE : SB50A04



PORTE SAVON
SOAP HOLDER
CODE : SB49A04

NOUVEAUTÉ! ✨
NOVELTY!



ETAGÈRE POUR SERVIETTE XL
XL RACK TOWEL
CODE : SB48A04

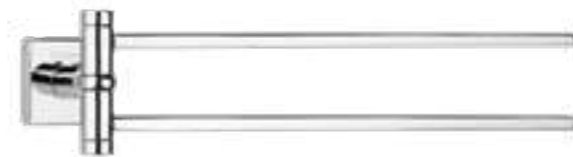

PORTE SERVIETTE DOUBLE MOBILE
DOUBLE MOBILE TOWEL HOLDER
CODE : SB74A04



PORTE SERVIETTES DOUBLE
DOUBLE TOWEL HOLDER
CODE : SB44A04



PORTE SERVIETTES SIMPLE
SINGLE TOWEL HOLDER
CODE : SB43A04



PORTE SAVON DE DOUCHE
SHOWER SOAP HOLDER
CODE : SB76A04



PORTE ESSUIE-MAINS
TOWEL HOLDER
CODE : SB42A04



PORTE ESSUIE MAIN SIMPLE
SINGLE TOWEL HOLDER
CODE : SB65A04

SÉRIE WARD WARD SET



NOUVEAUTÉ! ✨
NOVELTY!

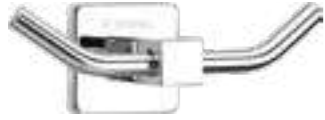

PORTE VÊTEMENTS

ROBE HOOK
CODE : SB41A04



DÉROULEUR DE PAPIER AVEC COUVERCLE

PAPER DISPENSER WITH COVER
CODE : SB82A04



DÉROULEUR DE PAPIER

TOILET PAPER HOLDER
CODE : SB40A04



PORTE SERVIETTE ANNEAU

TOWEL RING HOLDER
CODE : SB64A04



PORTE BALAI MURAL

WALL MOUNTED TOILET BRUSH
CODE : SB51A04



PORTE ROULEAU DE PAPIER

NAPKIN HOLDER
CODE : SB46A04



TABLETTE DOUBLE

DOUBLE SHELF
CODE : SB47A04



TABLETTE DE LAVABO AVEC GARDE-CORPS

SINK SHELF WITH RAILING
CODE : SB69A04



TABLETTE DE LAVABO

SINK SHELF
CODE : SB45A04



SÉRIE FELL
FELL SET



TABLETTE DE LAVABO
SINK SHELF
CODE : SB15A10



PORTE SERVIETTES GM
XL TOWEL HOLDER
CODE : SB06A10



PORTE ESSUIE TOUT
PAPER HOLDER
CODE : SB09A10



TABLETTE D'ANGLE
ANGLE SHELF
CODE : SB04A10



DÉROULEUR DE PAPIER
TOILET PAPER HOLDER
CODE : SB01A10



ETAGÈRE POUR SERVIETTES
RACK TOWEL
CODE : SB16A10



PORTE SERVIETTES PM
SM TOWEL HOLDER
CODE : SB07A10



PORTE BALAI MURAL
WALL MOUNTED TOILET BRUSH
CODE : SB10A10



PORTE VERRE
CUP HOLDER
CODE : SB02A10



PORTE ROULEAU DE PAPIER
NAPKIN HOLDER
CODE : SB05A10



PORTE VÊTEMENTS
ROBE HOOK
CODE : SB11A10



PORTE SAVON
SOAP HOLDER
CODE : SB03A10



PORTE SERVIETTES
TOWEL HOLDER
CODE : SB12A10



PORTE ESSUIE-MAINS
TOWEL HOLDER
CODE : SB08A10



NOUVEAUTÉ!
NOVELTY!



3X Agrandissement
magnification

- Facilité d'installation et de nettoyage
 - Fixations invisibles
 - Ergonomique : pratique, extensible et rabattable
- Easy to install and clean
- Invisible fasteners
- Ergonomic : practical, extendable and foldable

BRAS TÉLÉSCOPIQUE EN LAITON À 2 ARTICULATIONS
Brass telescopic arm with 2 joints

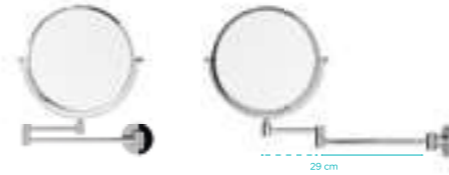

DOUBLE ROTATION 360°
Double 360° rotation

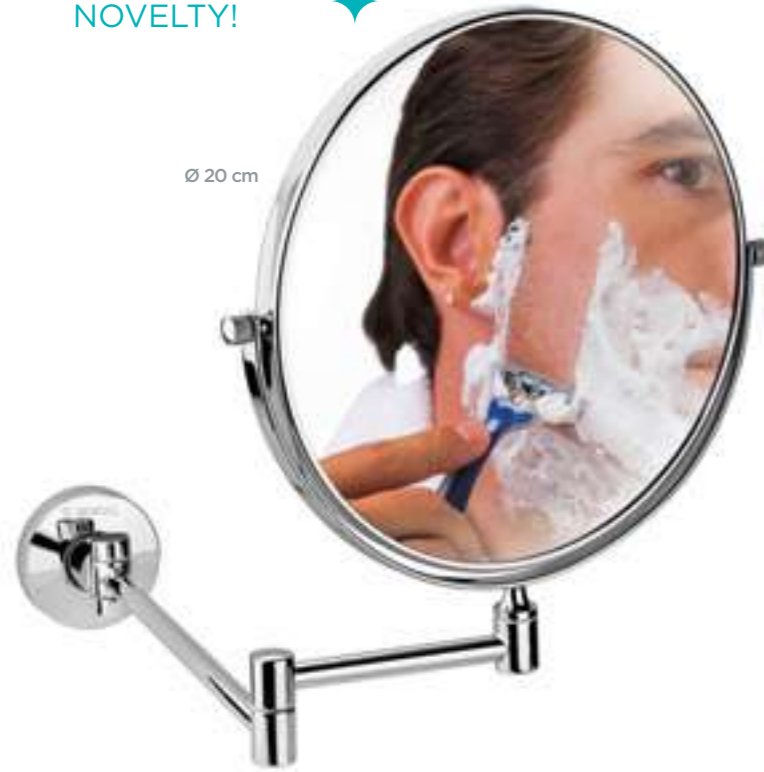

Ø 20 cm

MIROIR GROSSISSANT MURAL

MAGNIFYING MIRROR
CODE : SB89A04

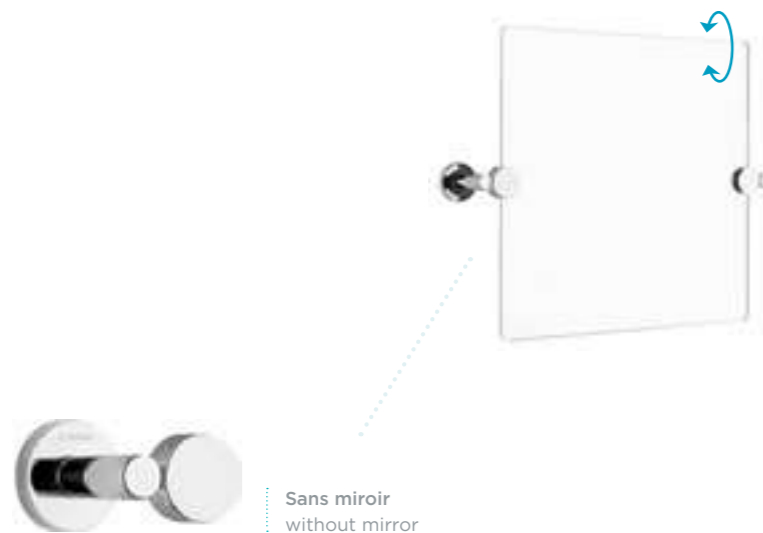

Sans miroir
without mirror

2 SUPPORTS DE MIROIR PIVOTANTS RONDS

2 ROUND SWIVEL MIRROR HOLDERS
CODE : SB78A04



Sans miroir
without mirror

2 SUPPORTS DE MIROIR PIVOTANTS CARRÉS

2 SQUARE SWIVEL MIRROR HOLDERS
CODE : SB88A04



- Discret et fait gagner de l'espace
- Ergonomique
- Solide
- Pratique et repliable
- Solution parfaite pour profiter de la douche en position assise

- Discreet and space saving
- Ergonomic
- Solid
- Practical and foldable
- Perfect solution to enjoy the shower from a sitting position

SIÈGE DE DOUCHE

SHOWER SEAT
CODE : SB67A00





NOUVEAUTÉS! ✨
NOVELTIES!



BARRE D'APPUI 120°
120° GRAB BAR
CODE : SB58A04



BARRE D'APPUI 400 mm
GRAB BAR 400 mm
CODE : SB23A04



BARRE D'APPUI 300 mm
GRAB BAR 300 mm
CODE : SB22A04



BARRE D'APPUI 200 mm
GRAB BAR 200 mm
CODE : SB21A04



BARRE D'APPUI RELEVABLE
FOLDING GRAB BAR
CODE : SB86A01



BARRE D'APPUI MUR ET SOL GAUCHE
LEFT WALL TO FLOOR GRAP BAR
CODE : SB87A01

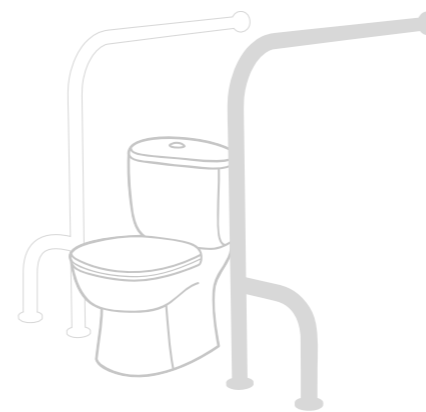

BARRE D'APPUI MUR ET SOL DROITE
RIGHT WALL TO FLOOR GRAB BAR
CODE : SB85A01





ESPACE CUISINE
KITCHEN SPACE

NOUVEAUTÉS!
NOVELTIES!

BIZERTE
MITIGEUR D'ÉVIER LONG
LONG SINK MIXER
CODE : 06DMA04

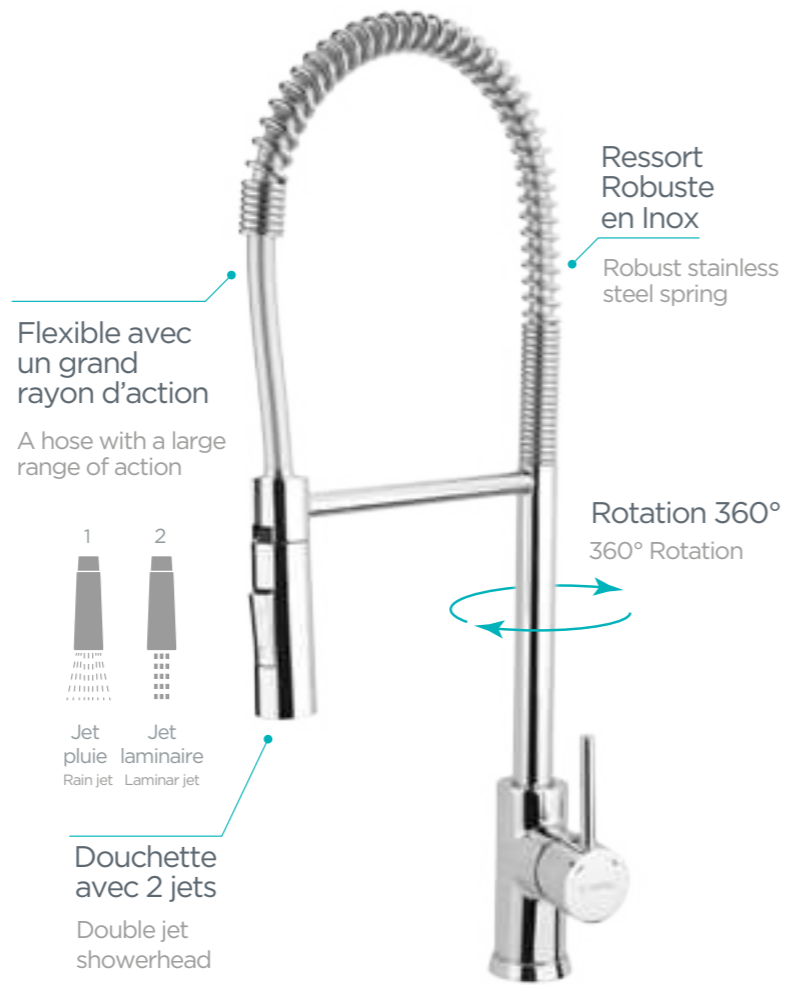

Flexible avec un grand rayon d'action

A hose with a large range of action

Ressort Robuste en Inox

Robust stainless steel spring

Rotation 360°
360° Rotation

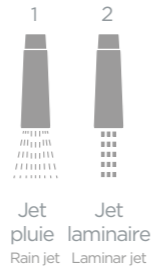

Douchette avec 2 jets
Double jet showerhead



Douchette avec 2 jets
Double jet showerhead

Rotation 120°
120° Rotation



BIZERTE
MITIGEUR D'ÉVIER AVEC DOUCHETTE EXTRACTIBLE
SINK MIXER WITH PULL-OUT SPOUT
CODE : 06DKA04



DOUZ
MITIGEUR D'ÉVIER AVEC DOUCHETTE EXTRACTIBLE
SINK MIXER WITH PULL-OUT SPOUT
CODE : 06ESA04



NOUVEAUTÉS!
NOVELTIES!

EASYFLEX

DES MITIGEURS DE CUISINE AVEC MÉMOIRE DE FORME
KITCHEN MIXERS WITH SHAPE MEMORY



COULEUR / COLOUR	CODE
ROUGE / RED	06DDA07
BLEU / BLUE	06DDA08
BLANC / WHITE	06DDA10
NOIR / BLACK	06DDA13
GRIS / GREY	06DDA18

MITIGEURS D'ÉVIER 3 ENTRÉES 3 INLETS SINK MIXERS



DJERBA
MITIGEUR D'ÉVIER 3 ENTRÉES 1 SORTIE
SINK MIXER 3 INLETS 1 OUTLET
CODE : 06DSA04

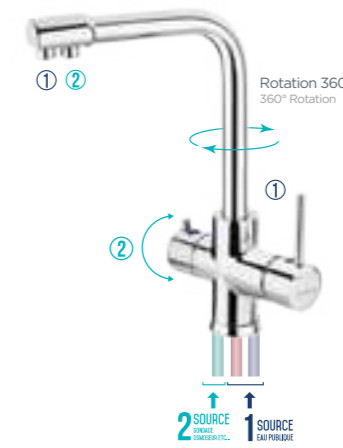

BIZERTE
MITIGEUR D'ÉVIER 3 ENTRÉES - 2 SORTIES
3 INLETS - 2 OUTLET SINK MIXER
CODE : 06DRA04



MITIGEURS D'ÉVIER SINK MIXERS

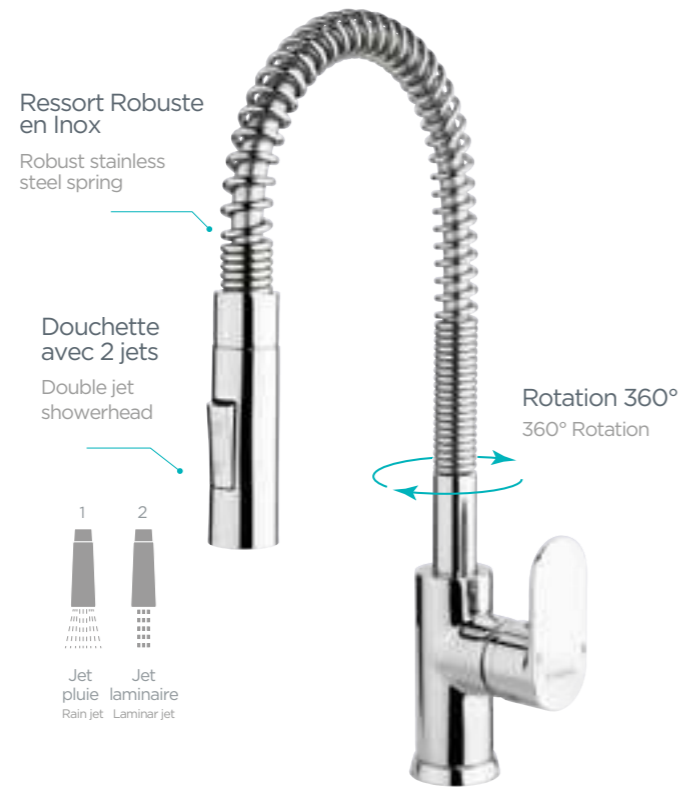

SFAX
MITIGEUR D'ÉVIER
SINK MIXER
CODE : 06C9A04



BIZERTE
MITIGEUR D'ÉVIER VERTICAL
VERTICAL SINK MIXER
CODE : 06CBA04



ZARZIS
MITIGEUR D'ÉVIER
SINK MIXER
CODE : 0643A04



DOUZ
MITIGEUR D'ÉVIER
SINK MIXER
CODE : 06APA04



MITIGEURS D'ÉVIER À COL DE CYGNE GOOSENECK SINK MIXERS



DIERBA
MITIGEUR D'ÉVIER À COL DE CYGNE
GOOSENECK SINK MIXER
CODE : 06CNA04



SOUSSE
MITIGEUR D'ÉVIER À COL DE CYGNE
GOOSENECK SINK MIXER
CODE : 06CPA04



KERKENNAH
MITIGEUR D'ÉVIER À COL DE CYGNE
GOOSENECK SINK MIXER
CODE : 06CLA04



ZEMBRA
MITIGEUR D'ÉVIER
SINK MIXER
CODE : 06DQA04



MITIGEURS D'ÉVIER AVEC DOUCHETTE AMOVIBLE

SINK MIXERS WITH REMOVABLE SHOWER



DOUCHETTE À DOUBLE JET

DOUBLE JET REMOVABLE SHOWER



SOUSSE

MITIGEUR D'ÉVIER DOUCHETTE AMOVIBLE
SINK MIXER WITH REMOVABLE SHOWER
CODE : 0613A04



DJERBA

MITIGEUR D'ÉVIER DOUCHETTE AMOVIBLE
SINK MIXER WITH REMOVABLE SHOWER
CODE : 0604A04



MÉLANGEURS D'ÉVIER

SINK MIXERS



MONASTIR

MÉLANGEUR D'ÉVIER
SINK MIXER
CODE : 04B5A04



TABARKA

MÉLANGEUR D'ÉVIER
SINK MIXER
CODE : 04CUA04



SALAKTA

MÉLANGEUR D'ÉVIER
SINK MIXER
CODE : 04BCA04



TOZEUR

MÉLANGEUR D'ÉVIER
SINK MIXER
CODE : 0451A04



MITIGEURS ET MÉLANGEURS D'ÉVIER MURAUX WALL MOUNTED MIXERS



DJERBA
MITIGEUR D'ÉVIER MURAL
WALL MOUNTED MIXER
CODE : 0670A04

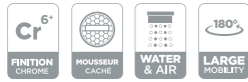

TOZEUR
MÉLANGEUR D'ÉVIER MURAL
WALL MOUNTED MIXER
CODE : 0456A04



KERKENNAH
MITIGEUR D'ÉVIER MURAL
WALL MOUNTED MIXER
CODE : 0671A04



SALAKTA
MÉLANGEUR D'ÉVIER MURAL
WALL MOUNTED MIXER
CODE : 04C1A04



ROBINETS VERTICAUX VERTICAL FAUCETS



TABARKA
ROBINET VERTICAL
VERTICAL FAUCET
CODE : 04D9A04



TOZEUR
ROBINET VERTICAL
VERTICAL FAUCET
CODE : 0457A04



SALAKTA
ROBINET VERTICAL
VERTICAL FAUCET
CODE : 04BPA04





ROBINETTERIE POUR COLLECTIVITÉS

COMMUNITIES
TAPS

ROBINETS TEMPORISÉ

TIMED FAUCETS



ROBINET LAVABO TEMPORISÉ
SELF-CLOSING NON-CONCUSSIVE
BATHROOM BASIN TAPS
CODE : 06E7A04



ROBINET MURAL TEMPORISÉ
SELF-CLOSING WALL-MOUNTED BASIN TAP
CODE : 06E8A04



ROBINET URINOIR TEMPORISÉ
TIME FLOW URINAL VALVE
CODE : 06EFA04



ROBINET URINOIR TEMPORISÉ ENTRÉE ENCASTRÉE
CONCEALED URINAL FLUSH VALVE SELF CLOSING
CODE : 06EGA04



ROBINET DE DOUCHE TEMPORISÉ ENCASTRÉ
SELF-CLOSING CONCEALED SHOWER VALVE
CODE : 06EBA04



ROBINET DOUCHE ENTRÉE ENCASTRÉE
SELF-CLOSING SHOWER TAP
CODE : 06EAA04



ROBINET DE DOUCHE TEMPORISÉ
SELF-CLOSING SHOWER TAP
CODE : 06E9A04



ROBINETS ÉLECTRONIQUES ELECTRONIC FAUCETS

1 L

6 L

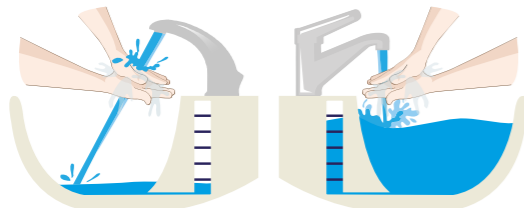

Robinet électronique
Electronic faucet

Robinet traditionnel
Traditional faucet

JUSQU'À
80%
D'ÉCONOMIE D'EAU

Up to 80% Water saving



Le robinet électronique ne se déclenche qu'en approchant vos mains du capteur infrarouge ainsi, vous garanteez un bon taux de consommation en eau, tout comme vous gagnez en hygiène dans la mesure où il n'y a aucun contact direct.

The electronic faucet is triggered only when you approach your hands to the infrared sensor. Thus, you guarantee a good rate of water consumption just as you gain in hygiene as far as there is no direct contact.



Avec pile 7.2V
With 7.2V battery



Avec secteur 100-240V
With 100-240V mains



NOUVEAUTÉ!
NOVELTY!

MAKTARIS

ROBINET ELECTRONIQUE MURAL
ELECTRONIC WALL FAUCET

CODE : 06DXA04
CODE : 06DYA04



NOUVEAUTÉ!
NOVELTY!

MAKTARIS

MITIGEUR ELECTRONIQUE VASQUE LONG
ELECTRONIC LONG NECK WASHBASIN MIXER

CODE : 06E5A04



NOUVEAUTÉ!
NOVELTY!

MAKTARIS

ROBINET ELECTRONIQUE VASQUE LONG
ELECTRONIC LONG NECK WASHBASIN FAUCET

CODE : 06E6A04



NOUVEAUTÉ!
NOVELTY!

AQUA

ROBINET ELECTRONIQUE POUR LAVABO
ELECTRONIC WASHBASIN FAUCET

CODE : 06CSA04
CODE : 06CTA04



HAIIRA

ROBINET ELECTRONIQUE POUR LAVABO
ELECTRONIC WASHBASIN FAUCET

CODE : 06ACA04
CODE : 06C7A04





LEVIER MITIGEUR BIZERTE
LEVER FOR BIZERTE MIXER
3196A04

LEVIER ROBINET DE TOILETTE BIZERTE
LEVER FOR BIZERTE LAVATORY MIXER
31A0A04

LEVIER MITIGEUR ZARZIS
LEVER FOR ZARZIS MIXER
3197A04

LEVIER ROBINET DE TOILETTE ZARZIS
LEVER FOR ZERZIS LAVATORY FAUCET
3199A04

LEVIER MITIGEUR SÉRIE DOUZ GM
BIG MODEL LEVER FOR DOUZ MIXER
31AKA04

LEVIER MITIGEUR SÉRIE DOUZ PM
SMALL MODEL LEVER FOR DOUZ MIXER
31ALA04

LEVIER ROBINET DE TOILETTE DOUZ
LEVER FOR DOUZ LAVATORY FAUCET
31AMA04

LEVIER MITIGEUR SOUSSE GM
BIG MODEL LEVER FOR SOUSSE MIXER
3108A04

LEVIER MITIGEUR SOUSSE MM
MEDIUM MODEL LEVER FOR SOUSSE
MIXER
3109A04

LEVIER MITIGEUR SOUSSE PM
SMALL MODEL LEVER FOR SOUSSE
MIXER
3146A04

LEVIER ROBINET DE TOILETTE SOUSSE
LEVER FOR SOUSSE LAVATORY FAUCET
3159A04

LEVIER MITIGEUR DJERBA GM
BIG MODEL LEVER FOR DJERBA MIXER
3107A04

LEVIER MITIGEUR DJERBA PM CARRÉ
SMALL MODEL LEVER FOR DJERBA
MIXER
3152A04

LEVIER ROBINET DE TOILETTE DJERBA
LEVER FOR DJERBA LAVATORY FAUCET
3153A04

VOLANT MITIGEUR EVIER 3 ENTREES
WHEEL MIXER SINK 3 INPUTS
3178A04

LEVIER MITIGEUR NABEUL
LEVER FOR NABEUL MIXER
31AYA04

LEVIER MITIGEUR SFAX
LEVER FOR SFAX MIXER
31AZA04

LEVIER ROBINET DE TOILETTE SFAX
LEVER FOR SFAX LAVATORY FAUCET
31B4A04

LEVIER MITIGEUR KERKENNAH
LEVER FOR KERKENNAH MIXER
3151A04

LEVIER ROBINET DE TOILETTE MITIGEUR
KERKENNAH

LEVER FOR KERKENNAH LAVATORY FAUCET
3160A04

VOLANT MONASTIR CHAUD/FROID
MONASTIR HANDLE HOT/COLD
3173A04

VOLANT TABARKA CHAUD/FROID
TABARKA HOT/COLD HANDLE
3121A04

VOLANT TOZEUR ROUGE CHAUD/FROID
TOZEUR HOT/COLD HANDLE
3158A04

VOLANT SALAKTA CHAUD/FROID
SALAKTA HOT/COLD HANDLE
3143A04

BEC NM EVIER SALAKTA
SALAKTA SINK MIXER SPOUT
4942A04

BEC LAVABO SALAKTA
SALAKTA WASHBASIN MIXER SPOUT
4941A04

BEC MURAL Ø 24 L160 90
WALL SPOUT Ø 24 L160 90
4936A04

BEC MURAL 18 1/2" F
WALL SPOUT 18 1/2" F
4927A04

BEC LAVABO ROND Ø24 AVEC
MOUSSEUR
ROUND WASHBASIN SPOUT Ø24 WITH
AERATOR
4902A04

BEC EVIER ROND Ø24 AVEC MOUSSEUR
ROUND SINK SPOUT Ø24 WITH AERATOR
4937A04

ENSEMBLE ROSACE BOMBÉE
EXCENTRIQUE
ECCENTRIC CONVEX ROSETTE SET
0898A00

ENSEMBLE ROSACE CYLINDRIQUE
EXCENTRIQUE
ECCENTRIC CYLINDRICAL ROSETTE SET
08DYA00

ENSEMBLE ROSACE CARREE AVEC
EXCENTRIQUE
ECCENTRIC SQUARE ROSETTE SET
4049A04

CHAPEAU M24X1 CHROME POUR TETE
CAP M24X1 CHROME FOR HEADWORK
2811A04

ROSACE INOX POUR ROBINET DE
TOILETTE
ROSACE LAVATORY FAUCET
4003A00

CARTOUCHE Ø35 DEUX POSITIONS
TYPE A
CARTRIDGE Ø35 TWO POSITIONS
TYPE A



0915A00
CARTOUCHE Ø35 DEUX POSITIONS
TYPE B

CARTRIDGE Ø35 TWO POSITIONS
TYPE B

0916A00
CARTOUCHE Ø40 DEUX POSITIONS
TYPE A

CARTRIDGE Ø40 TWO POSITIONS
TYPE A

0920A00
CARTOUCHE Ø40 DEUX POSITIONS
TYPE B

CARTRIDGE Ø40 TWO POSITIONS
TYPE B

0921A00
CARTOUCHE Ø40 UNE POSITION
TYPE A

CARTRIDGE Ø40 ONE POSITION
TYPE A

0926A00
CARTOUCHE Ø40 UNE POSITION
TYPE B

CARTRIDGE Ø40 ONE POSITION
TYPE B

0943A00
CARTOUCHE Ø35 UNE POSITION
TYPE B

CARTRIDGE Ø35 ONE POSITION
TYPE B

0944A00
CARTOUCHE Ø40 ECO ENERGY
TYPE B

CARTRIDGE Ø40 ECO-ENERGY
TYPE B

0956A00
CARTOUCHE Ø35 ECO ENERGY
TYPE B

CARTRIDGE Ø35 ECO-ENERGY
TYPE B

0957A00
CARTOUCHE Ø25 JOYSTICK
TYPE C

CARTRIDGE Ø25 JOYSTIQUE
TYPE C

0961A00
CARTOUCHE Ø35 UNE POSITION
TYPE D

CARTRIDGE Ø35 ONE POSITION
TYPE D

0963A00
TÊTE EN CÉRAMIQUE 1/2 TOUR DROITE
CERAMIC HEADWORK HALF TURN RIGHT
0911B01

0928A01
TÊTE EN CÉRAMIQUE 1/4 TOUR DROITE
DURE
CERAMIC HEADWORK QUARTER TURN
RIGHT

0938A01
TÊTE CERAMIQUE 1/4 TOUR MITIGEUR 3
ENTRÉES
3 INLETS SINK MIXER CERAMIC HEADWORK
QUARTER TURN

0938A01
TÊTE CERAMIQUE 1/4 TOUR MITIGEUR 3
ENTRÉES

3 INLETS SINK MIXER CERAMIC
HEADWORK QUARTER TURN
0964A01

TÊTE EN CERAMIQUE 1/2 TOUR GAUCHE
CERAMIC HEADWORK HALF TURN LEFT
0910B01

TÊTE MELANGEUR TOZEUR/TABARKA
HEADWORK FOR TOZEUR /TABARKA
MIXER
0913B01

TÊTE MELANGEUR 3/8"
3/8" HEADWORK FOR MIXER
0924A01

ENSEMBLE DE FIXATION 1 TIGE
L60 JOINT Ø42
BASIN TAP FIXING SET WITH SINGLE
BOLT L60 AND WASHER Ø42
0843A00

ENSEMBLE DE FIXATION 1 TIGE
L85 SYM JOINT Ø44
BASIN TAP FIXING SET WITH SINGLE
BOLT L85 AND WASHER Ø44
08CWA01

ENSEMBLE DE FIXATION 2 TIGES
L60 JOINT Ø42
BASIN TAP FIXING SET WITH DOUBLE
BOLTS L60 AND WASHER Ø42
08ADA00

ENSEMBLE DE FIXATION 2 TIGES
L115 JOINT Ø44
BASIN TAP FIXING SET WITH DOUBLE
BOLTS L115 AND WASHER Ø44
08CUA00

ENSEMBLE DE FIXATION 2 TIGES
L280 JOINT Ø44
BASIN TAP FIXING SET WITH DOUBLE
BOLTS L280 AND WASHER Ø44
08CVA00

ENSEMBLE DE FIXATION ÉVIER
AMOVIBLE
BASIN TAP FIXING SET
08DFA01

PAIRE DE FLEXIBLES MF M10X1 - G3/8»
(DN8) L360
PAIR OF FLEXIBLE METAL HOSE MF M10X1
- G3/8" (DN8) L 360 MM
4404A00

PAIRE DE FLEXIBLES MF M10X1 - G3/8»
(DN8) L500
PAIR OF FLEXIBLE METAL HOSE MF M10X1
- G3/8" (DN8) L 500 MM
4412A00

PAIRE DE FLEXIBLES MF M10 X 1-G3/8»
(DN8) L500 LONG
PAIR OF LONG FLEXIBLE METAL HOSE MF
M10X1 - G3/8" (DN8) L 500 MM
4414A00

PAIRE DE FLEXIBLES MF M10 X 1-G3/8»
(DN8) L360 LONG
PAIR LONG FLEXIBLE METAL HOSE MF
M10X1 - G3/8" (DN8) L 360 MM
4415A00

FLEXIBLE MF M10 X 1 - G1/2" L360
FLEXIBLE METAL HOSE MF M10X1 - G1/2"
(DN8) L 360 MM



4416A00

FLEXIBLE MF M10 X 1 - G1/2" L500
FLEXIBLE METAL HOSE MF M10X1 - G1/2"
(DN8) L 500 MM

4417A00

JOINT TORIQUE Ø16.5 X Ø2.5
O-RING Ø16.5 X Ø2.5

3713A00

JOINT TORIQUE Ø15.8 X Ø1.8
O-RING Ø15.8 X Ø1.8

3754A00

KIT JOINT D'ÉTANCHÉITÉ ÉVIER Ø 40
SEAL SET FOR SINK MIXER Ø 40

3831A00

KIT JOINT D'ÉTANCHÉITÉ ÉVIER Ø 35
SEAL SET FOR SINK MIXER Ø 35

3844A00

FLEXIBLE COMPLET POUR DOUCHETTE
AMOVIBLE
FEXIBLE SET FOR REMOVABLE SHOWER
HEAD

4405A00

ENSEMBLE DE FIXATION POUR EVIER
INOX
FIXING SET FOR STAINLESS STEEL SINK

08H2A00

ENSEMBLE SUPPORT DE FIXATION POUR
BARRE DE DOUCHE
SHOWER BAR FIXING HOLDER SET

08FHA00

PLAQUETTES BEIGE NATUREL F/C
BEIGE COLD INDEX BUTTON (F)/(C)

1182A11

CLOCHE Ø54 M52X19F F
COVER FLANGE Ø54 M52X19F F

0836A04

CLOCHE Ø48
COVER FLANGE Ø48

0837A04

CLOCHE M37 X 1.5 M
COVER FLANGE M37 X 1.5 M

08CBA04

CLOCHE Ø39
COVER FLANGE Ø39

08D4A04

KIT INVERSEUR DJERBA
DJERBA DIVERTER KIT

08DAA04

KIT INVERSEUR SALAKTA
SALAKTA DIVERTER KIT

08D9A04

KIT INVERSEUR SOUSSE
SOUSSE DIVERTER KIT

08DBA04

KIT INVERSEUR BIZERTE ET DOUZ
(ENCASTREE)
BIZERTE AND DOUZ DIVERTER KIT
(RECESSED)

08DSA04

KIT INVERSEUR SFAX/DOUZ
SFAX/DOUZ DIVERTER KIT

08KHA04

KIT INVERSEUR KERKENNAH
KERKENNAH DIVERTER KIT

08KMA04

KIT INVERSEUR ZARZIS
ZARZIS DIVERTER KIT

08KKA04

KIT INVERSEUR NABEUL
NABEUL DIVERTER KIT

08KJA04

KIT INVERSEUR BIZERTE/MONASTIR
BIZERTE/MOUNASTIR DIVERTER KIT

08KLA04

KIT INVERSEUR TABARKA/TOUZEUR
TABARKA/TOUZEUR DIVERTER KIT

08KNA04

INVERSEUR CÉRAMIQUE Ø35 CARRÉ /
SFAX
CERAMIC Ø35 SQUARE DIVERTER / SFAX

0974A00

DOUCHETTE AMOVIBLE POUR MITIGEUR
EVIER REMOVABLE
SHOWER HEAD FOR SINK MIXER

10ALA04

MOUSSEUR M22 F
AERATOR M22 F

4603A04

MOUSSEUR M28 M
AERATOR M28 M

4604A04

MOUSSEUR M24 M
AERATOR M24 M

4606A04

MOUSSEUR ARTICULABLE M24 M
ARTICULABLE AERATOR M24 M

4607A04

MOUSSEUR ENCASTRE M16.5 X 1
EMBEDDED AERATOR M16,5X1

4612A04

MOUSSEUR COIN-SLOT M24X1
COIN-SLOT AERATOR M24X1

4613A00

MOUSSEUR COIN-SLOT M24X1 PCA ROSE
4,5L/MN

COIN-SLOT AERATOR M24X1 PCA PINK
4,5L/MIN

4625A00

MOUSSEUR DOUBLE JET M22X1 F
DOUBLE JET AERATOR M22X1 F

4619A00

BATTERIE LITHIUM 7,2V
7,2V LITHIUM BATTERY

58HCA00



www.sopal.com



TUNISIE / SIÈGE SOCIAL:

Route de Gabès km 1,5 - 3003 Sfax
Tél. : +216 74 46 89 00
Fax : +216 74 46 82 18
E-mail : ventes@sopal.com

MAROC / SOPAMAR:

Tél. : +212 522 69 10 23
E-mail : maroc@sopal.com

CÔTE D'IVOIRE / SOPAL AFRIQUE:

Tél. : +225 27 22 41 82 13
Mob. : +225 07 57 75 54 70
E-mail : ci@sopal.com



bimobject®

